



COMMERCIAL FURNITURE
OUTDOOR + INDOOR

QUICKSHIP
2025



WWW.BUMOUTDOOR.CA









**ONE OF
NORTH
AMERICA'S
LARGEST
INVENTORY OF
COMMERCIAL
PATIO FURNITURE
FOR:**

RESTAURANTS

HOTELS

CONDO TERRACES

GOLF COURSES

PRIVATE CLUBS

EDUCATIONAL SETTINGS

OUTDOOR MEETING SPACES

AMUSEMENT PARKS

MUNICIPAL PARKS

CORPORATE OUTDOOR SPACES

RETIREMENT RESIDENCE PATIOS

RESIDENTIAL PATIOS



COMMERCIAL FURNITURE

OUTDOOR + INDOOR

QUICKSHIP 2025 TABLE OF CONTENTS

ICON LEGEND.....	6
ARMCHAIRS	7
ARMCHAIR CUSHIONS	27
SIDE CHAIRS	28
SIDE CHAIR CUSHIONS	50
BAR STOOLS.....	51
TABLES: DINING HEIGHT.....	75
TABLES: BAR HEIGHT	103
EMU TABLETOPS & BASES	112
BUM TABLETOPS	115
DINING BASES	122
BAR BASES.....	126
LOUNGE SEATING	129
LOUNGE CUSHIONS.....	157
LOUNGE SUN BEDS.....	159
LOUNGE TABLES.....	166
COMPLEMENTS.....	179
SHADE	192
PLANTERS	207
FLAME	215
SWATCHES	222
TERMS & CONDITIONS	227
INSTALLATION SERVICES	232



Our chairs are tested and rated to hold 300 lbs



QUICKSHIP 2025

ICON LEGEND



Special Order Colours
Expect 12-16 Weeks for delivery



Specially Treated for High Salinity
Environments



Non Slip Replaceable Feet



Stackable



Nesting



Remote Control Included



Umbrella Hole



Assembly Required



Adjustable Feet



ADA/AODA Compliant

ARMCHAIRS



ARMCHAIRS

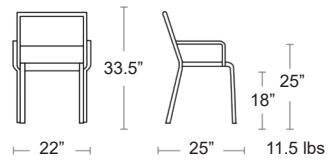

Sid

Square tubular aluminum frame,
Wood-look E-Plated Powder Coat finish,
aluminum slat seat and back
MSRP: \$740 EA. SELL: \$480 EA.

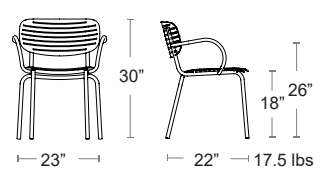
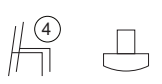
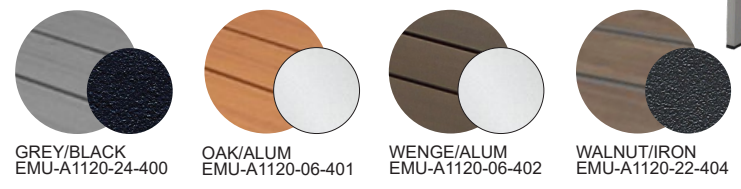

Mom

Tubular steel frame, Solid steel slat seat and back,
E-Plated Powder Coat finish
MSRP: \$620 EA. SELL: \$405 EA.

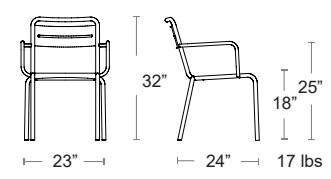
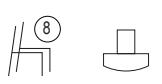

Star

Tubular steel frame, Solid steel slat seat and back,
E-Plated Powder Coat finish
MSRP: \$600 EA. SELL: \$390 EA.

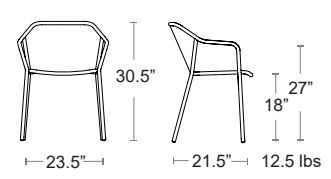
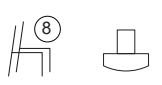

Darwin

Tubular steel frame Extended Steel Mesh seat and back,
E-Plated Powder Coat finish
MSRP: \$570 EA. SELL: \$370 EA.



ARMCHAIRS

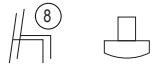

Ronda 2.0

Tubular steel frame, Extended steel mesh seat and back, E-Plated Powder Coat finish

MSRP: \$490 EA. SELL: **\$320 EA.**

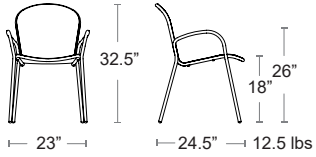

MARINE
BLUE
EMU-E458-16



IRON
EMU-E458-22



WHITE
EMU-E458-23

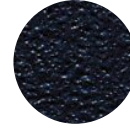

BLACK
EMU-E458-24

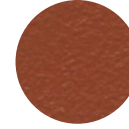

MAPLE
RED
EMU-E458-26



ARMCHAIRS

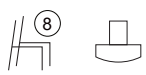

RECLIPS

Stackable chairs with plastic slats made from 97% recycled polypropylene + colour pigments + UV protection, clipped on a E-Plated Powder Coat aluminum frame with optional Bamboo arm rests.

MSRP: \$480 EA. SELL: \$315 EA.

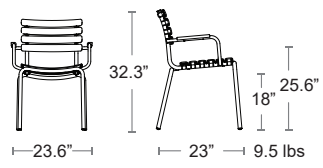

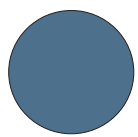
-  SKY BLUE
*A-HOUE-22302-1414-14
-  BLACK
*A-HOUE-22302-2024-24
-  DARK GREY
*A-HOUE-22302-7026-26
-  OLIVE GREEN
*A-HOUE-22302-2727-27



BAMBOO ARMS available
FOR ALL COLOURS
*A-HOUE-BAMBOO ARM REST-03

MSRP: \$20 PAIR

SELL: \$13 PAIR



ARMCHAIRS

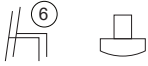

Sanibel

All Welded Aluminum Frame, one-piece Quick Dry Foam padded sling seat/back, E-Plated Powder Coat finish

MSRP: \$480 EA. SELL: \$315 EA.

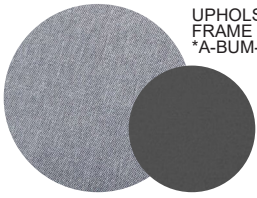
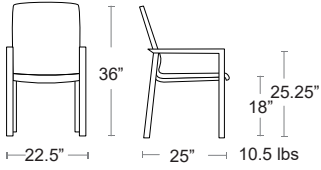

UPHOLSTERY - PFIFER SLING CHARCOAL
FRAME - ANTRACITE
*A-BUM-SB-320



ARMCHAIRS



Capri Bucket

Black All Weather Rope back & arms. Antracite round tubular aluminum E-Plated Powder Coat frame, Textaline seat cushion

MSRP: \$460 EA. SELL: \$300 EA.

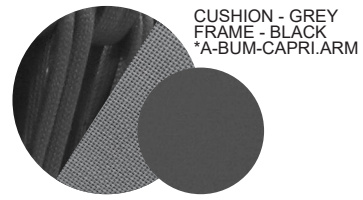
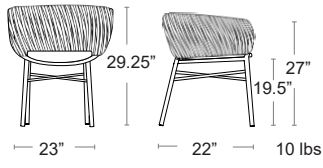
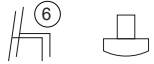

CUSHION - GREY
FRAME - BLACK
*A-BUM-CAPRI.ARM



ARMCHAIRS



Adico #508

Tubular steel frame, Solid steel seat and back, E-Plated Powder Coat finish

MSRP: \$380 EA. SELL: \$250 EA.

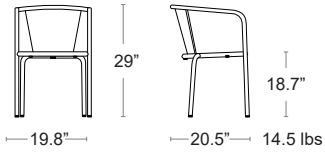

YELLOW
*A-ADC-508-1002

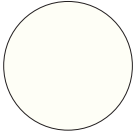

WHITE
*A-ADC-508-1310



ORANGE
*A-ADC-508-2012



RED
*A-ADC-508-3169



GREEN
*A-ADC-508-6021



BLUE
*A-ADC-508-6034

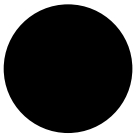

BLACK
*A-ADC-508-9005



ARMCHAIRS

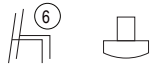

Marco Sling

Square tubular aluminum frame, E-Plated Powder Coat finish, Batyline Seat & Back, Polywood armrests

MSRP: \$350 EA. SELL: \$230 EA.

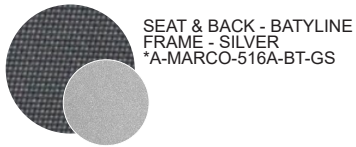
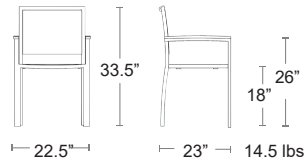

ARMCHAIRS

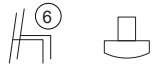

Marco Polywood

Square tubular aluminum frame, E-Plated Powder Coat finish, Polywood Seat, Back & Armrests

MSRP: \$350 EA. SELL: \$230 EA.

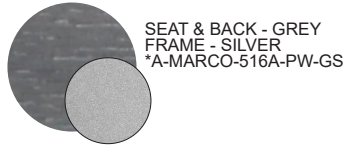
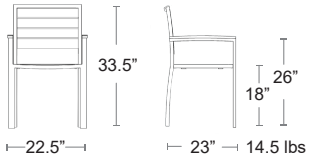

ARMCHAIRS

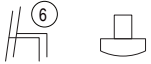

Marco Wicker

Square tubular aluminum frame, E-Plated Powder Coat finish, Viro Wicker Seat & Back, Polywood armrests

MSRP: \$350 EA. SELL: \$230 EA.

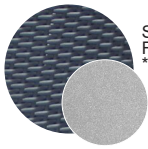
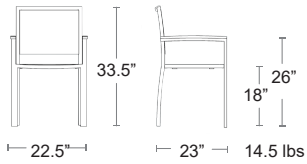

SEAT & BACK - VIRO GRAPHITE
FRAME - SILVER
*A-MARCO-516A-SW-BS

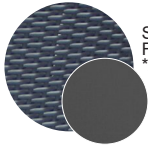

SEAT & BACK - VIRO GRAPHITE
FRAME - ANTRACITE
*A-MARCO-516A-SW-BA





ARMCHAIRS



NARDI
YOUR OUTDOOR LIVING

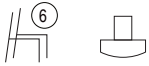

Net

Uniformly coloured fiberglass polypropylene with UV additives
Matte finish, Non-slip feet, Recyclable,
See in stock cushions, Page 27

MSRP: \$240 EA. SELL: \$180 EA.

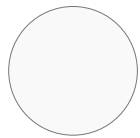
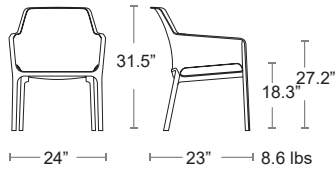

BIANCO
*A-NAR-40326.00

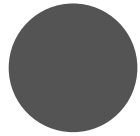

ANTRACITE
*A-NAR-40326.02



SALICE
*A-NAR-40326.04

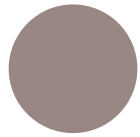

TORTORA
*A-NAR-40326.10



SENAPE
*A-NAR-40326.56



CORALLO
*A-NAR-40326.75



ARMCHAIRS



Doga

Uniformly coloured fiberglass and polypropylene with UV additives
Matte finish, Non-slip feet, Recyclable
See in stock cushions, Page 27

MSRP: \$240 EA. SELL: \$180 EA.

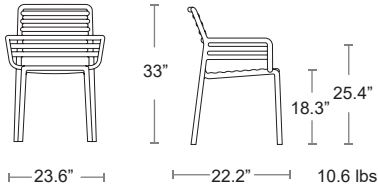

ARMCHAIRS

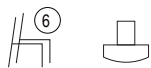

Tiberina

Uniformly coloured fiberglass polypropylene with UV additives
Matte finish, Non-slip feet, Recyclable



MSRP: \$240 EA. SELL: \$180 EA.

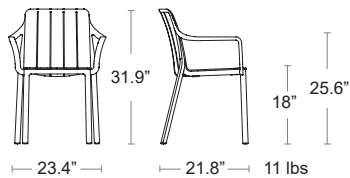

ANTRACITE
*A-NAR-40205.02



TORTORA
*A-NAR-40205.10



CORDA
*A-NAR-40205.24



TERRA
*A-NAR-40205.44



ARMCHAIRS

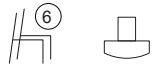

Trill

Uniformly coloured fiberglass and polypropylene with UV additives
Matte finish, Non-slip feet, Recyclable
See in stock cushions, Page 27

MSRP: \$240 EA. SELL: \$180 EA.

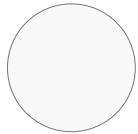
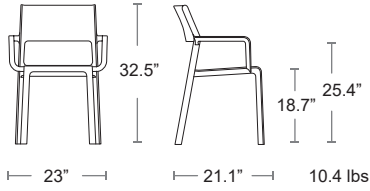

BIANCO
*A-NAR-40250.00

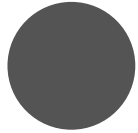

ANTRACITE
*A-NAR-40250.02



GRIGIO
*A-NAR-40250.03



TORTORA
*A-NAR-40250.10



AGAVE
*A-NAR-40250.16



OTTANIO
*A-NAR-40250.49



SENAPE
*A-NAR-40250.56



ROSA BOUQUET
*A-NAR-40250.08



TABACCO
*A-NAR-40250.53



ARMCHAIRS



PAPATYA

Luna

Uniformly coloured fiberglass and polypropylene, Matte finish, Polycarbonate and Resin back, with UV additives, Non-slip feet, Recyclable

MSRP: \$220 EA. **SELL: \$140 EA.**

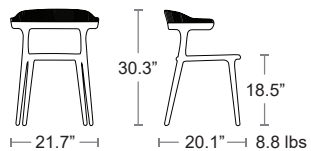
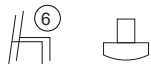

WHITE / CLEAR
*A-PPY-LUNA-01-37



ANTRACITE / SMOKE
*A-PPY-LUNA-22-38



ARMCHAIRS



PAPATYA

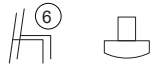

Mambo

Uniformly coloured fiberglass and polypropylene with UV additives, Matte finish, Non-slip feet, Recyclable

MSRP: \$220 EA. **SELL: \$140 EA.**

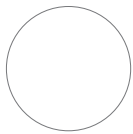
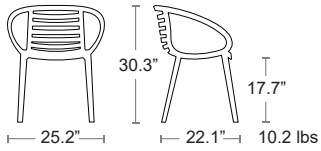

WHITE
*A-PPY-MAMBO-01



ANTRACITE
*A-PPY-MAMBO-22



ARMCHAIRS



NARDI
YOUR OUTDOOR LIVING

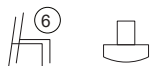





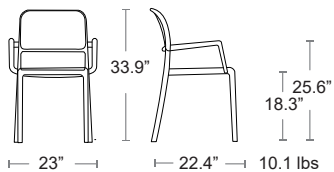

Riva

Uniformly coloured fiberglass and polypropylene with UV additives
Matte finish, Solid seat and back, Non-slip feet, Recyclable,
See in stock cushions Page 27

MSRP: \$210 EA. SELL: \$140 EA.



-  BIANCO
*A-NAR-40246.00
-  ANTRACITE
*A-NAR-40246.02
-  ROSSO
*A-NAR-40246.07
-  TORTORA
*A-NAR-40246.10
-  AGAVE
*A-NAR-40246.16
-  CELESTE
*A-NAR-40246.39

ARMCHAIRS

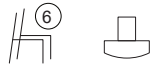



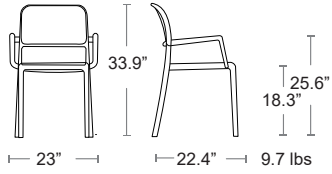

Bora

Uniformly coloured fiberglass and polypropylene with UV additives, Matte finish, Perforated seat and back, Non-slip feet, Recyclable, See in stock cushions Page 27

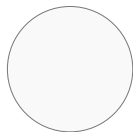
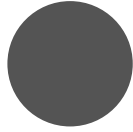
MSRP: \$210 EA. SELL: \$140 EA.



-  BIANCO
*A-NAR-40242.00
-  ANTRACITE
*A-NAR-40242.02
-  ROSSO
*A-NAR-40242.07
-  TORTORA
*A-NAR-40242.10
-  AGAVE
*A-NAR-40242.16
-  CELESTE
*A-NAR-40242.39

ARMCHAIRS



NARDI
YOUR OUTDOOR LIVING

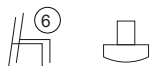

Costa

Uniformly coloured fiberglass and polypropylene with UV additives
Matte finish, Solid seat and ladder back, Non-slip feet, Recyclable,
See in stock cushions Page 27

MSRP: \$210 EA. SELL: \$140 EA.

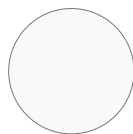
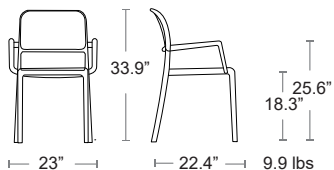

BIANCO
*A-NAR-40244.00

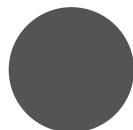

ANTRACITE
*A-NAR-40244.02



ROSSO
*A-NAR-40244.07



TORTORA
*A-NAR-40244.10



AGAVE
*A-NAR-40244.16

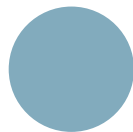

CELESTE
*A-NAR-40244.39



Armchair Cushions

Made in North America, Sunbrella 100% Solution dyed acrylic, Zippered removable cover, washable,
 Custom Sunbrella Colours available for a 25% Surcharge
MSRP: \$70 EA. SELL: \$45 EA.

Armchair Cushion

Fits Trill, Riva, Bora, Costa, With ties

*C-BUM-GENERIC + COLOUR CODE

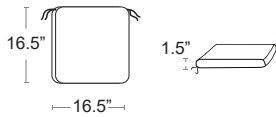

Net Cushion

No ties

*C-BUM-NET + COLOUR CODE

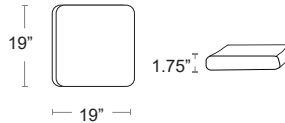

Doga Cushion

Velcro ties

*C-BUM-DOGA + COLOUR CODE

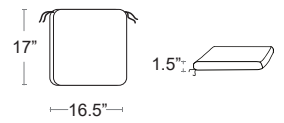

SPECTRUM EGGSHELL
-48018

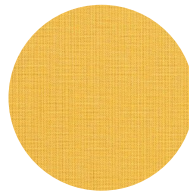

SPECTRUM DAFFODIL
-48024

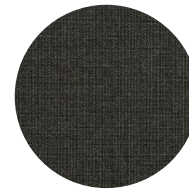

SPECTRUM CARBON
-48085

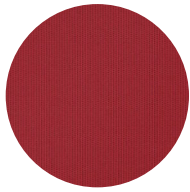

SPECTRUM CHERRY
-48096



CANVAS GRANITE
-5402

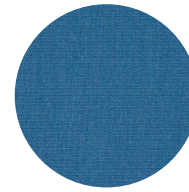

CANVAS REGATTA
-5493

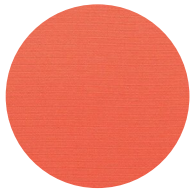

CANVAS MELON
-5415

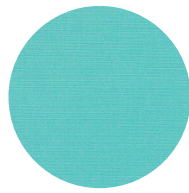

CANVAS ARUBA
-5416

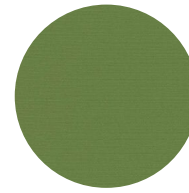

CANVAS PALM
-5421



DOLCE MANGO
-56000



DOLCE OASIS
-56001

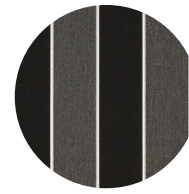

PEYTON GRANITE
-56075



MILANO CHAR
-56079



CABANA REGATTA
-58029



CABANA CLASSIC
-58030



Custom Cushions & Special Orders

We can make cushions for all the chairs and stools we sell in available Sunbrella Fabric
 We have swatches and samples of Special Order colours and fabrics.
 Contact BUM for samples and pricing samplerrequest@bumoutdoor.ca

SIDE CHAIRS



SIDE CHAIRS



Rio Bench ALU

Aluminum frame and seat, E-Plated Powder Coat finish, Adjustable height feet

MSRP: \$940 EA. SELL: \$705 EA.

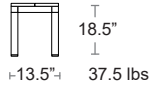
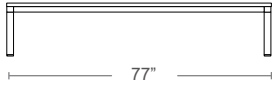
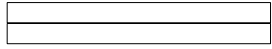

RIO BENCH ALU
BIANCO
*S-NAR-49053.00



RIO BENCH ALU
ANTRACITE
*S-NAR-49052.02



RIO BENCH ALU
TORTORA
*S-NAR-49059.10



SIDE CHAIRS

SIDE CHAIRS



Jakarta Folding

Teak frame with Batyline Duo Structural Fabric™ sling for durability and longevity. The slings are suspended in an aluminum channel with the edges sewn around a poly core

MSRP: \$840 EA. SELL: \$545 EA.

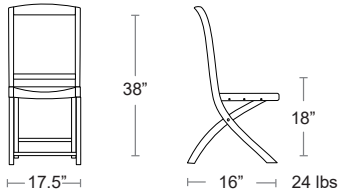

SIDE CHAIRS



Marco Polywood Bench

Square tubular aluminum frame, E-Plated Powder Coat finish, Polywood Seat & Back

MSRP: \$750 EA. SELL: \$490 EA.

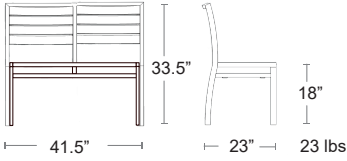

ANTRACITE/TEAK
*S-MARCO-BES-516-TA



ANTRACITE/GREY
*S-MARCO-BES-516-GA



SILVER/GREY
*S-MARCO-BES-516-GS



SILVER/TEAK
*S-MARCO-BES-516-TS



Connecting hardware included with orders of 2 or more

SIDE CHAIRS

SIDE CHAIRS



emuamericas



Sid

Square tubular aluminum frame,
Wood-look Aluminum slat seat and back,
E-Plated Powder Coat finish

MSRP: \$640 EA. SELL: \$415 EA.

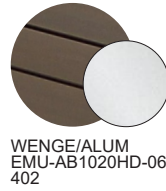
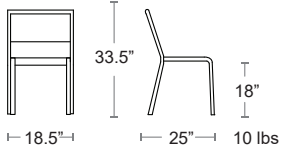

emu



Code

Tubular steel frame, Solid steel seat and back,
E-Plated Powder Coat finish

MSRP: \$600 EA. SELL: \$390 EA.

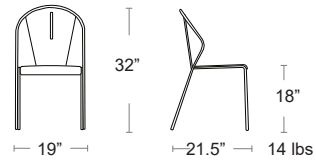

emuamericas



Anna

Square tubular aluminum frame, Solid aluminum seat and slat
back, Brushed aluminum with lacquered clear coat

MSRP: \$570 EA SELL: \$370 EA

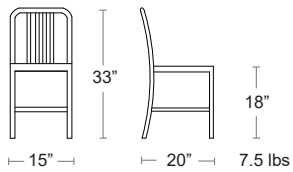

NARDI
YOUR OUTDOOR LIVING



Mom

Tubular steel frame, Solid steel slat seat and back,
E-Plated Powder Coat finish

MSRP: \$570 EA. SELL: \$370 EA.

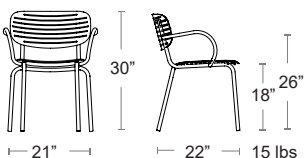

SIDE CHAIRS

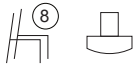

Star

Tubular steel frame, Solid steel slat seat and back
E-Plated Powder Coat finish

MSRP: \$540 EA. SELL: \$350 EA.

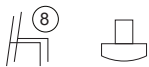
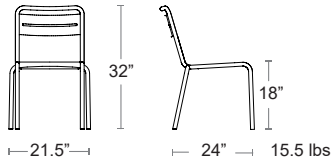

Darwin

Tubular steel frame, Extended steel mesh seat and back
E-Plated Powder Coat finish

MSRP: \$500 EA. SELL: \$325 EA.

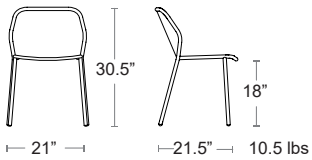

Ronda 2.0

Tubular steel frame, Extended steel mesh seat and back,
E-Plated Powder Coat finish

MSRP: \$440 EA. SELL: \$285 EA.

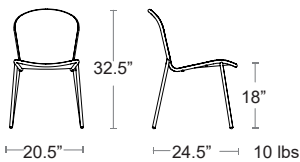

**“FURNITURE IS MEANT TO BE FUNCTIONAL AND ARTISTIC;
AT BUM OUTDOOR FURNITURE, WE ENSURE IT IS BOTH”**

SIDE CHAIRS



Adico #786A

Tubular steel frame, Solid steel seat and back, E-Plated Powder Coat finish



MSRP: \$370 EA. **SELL: \$240 EA.**

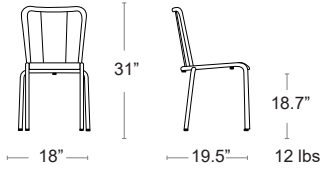

YELLOW
*S-ADC-786A-1002

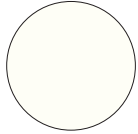

WHITE
*S-ADC-786A-1310



ORANGE
*S-ADC-786A-2012



RED
*S-ADC-786A-3169



GREEN
*S-ADC-786A-6021



BLUE
*S-ADC-786A-6034

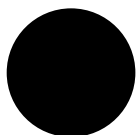

BLACK
*S-ADC-786A-9005



SIDE CHAIRS

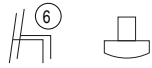

Marco Sling

Square tubular aluminum frame, E-Plated Powder Coat finish, Batyline Seat & Back

MSRP: \$340 EA. SELL: \$220 EA.

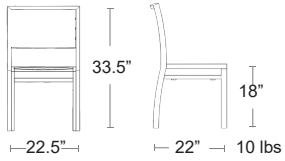

BATYLINE - SEAT & BACK
FRAME - SILVER
*S-MARCO-516S-BT-GS

BATYLINE - SEAT & BACK
FRAME - BLACK
*S-MARCO-516S-BT-GA



SIDE CHAIRS

SIDE CHAIRS

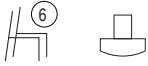

Marco Polywood

Square tubular aluminum frame, E-Plated Powder Coat finish, Polywood Seat & Back

MSRP: \$340 EA. **SELL: \$220 EA.**

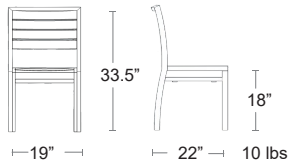

SIDE CHAIRS

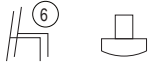

Marco Wicker

Square tubular aluminum frame, E-Plated Powder Coat finish, Viro Wicker Seat & Back

MSRP: \$340 EA. SELL: \$220 EA.

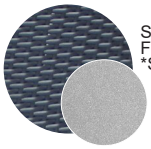
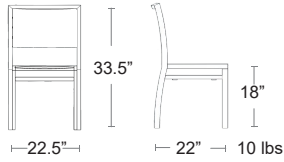

SEAT & BACK - VIRO GRAPHITE
FRAME - SILVER
*S-MARCO-516S-SW-BS

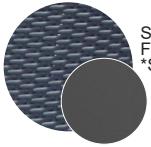

SEAT & BACK - VIRO GRAPHITE
FRAME - ANTRACITE
*S-MARCO-516S-SW-BA



SIDE CHAIRS

SIDE CHAIRS



Parisian

All-welded Aluminum frame, wood-look E-Plated Powder Coat finish with all weather wicker seat and back, replaceable feet.

MSRP: \$320 EA. SELL: \$210 EA.

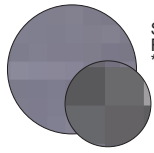
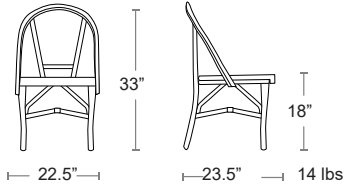

SEAT & BACK - BLACK & WHITE
FRAME - TEAK
*S-BUM-AC3501N01RAT



SIDE CHAIRS



Arc En Ciel Folding

Steel frame, Steel slat seat and back,
E-Plated Powder Coat finish

MSRP: \$270 EA. SELL: \$175 EA.

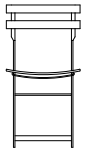

32"



18"

17"

17" 10.5 lbs



MARINE BLUE
EMU-E314-16



IRON
EMU-E314-22

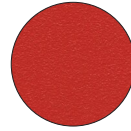

CHERRY
EMU-E314-50

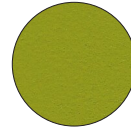

GREEN
EMU-E314-60



SIDE CHAIRS



NEW!
INDOOR

Ciao Bella Indoor

Oak Wood Frame, Rattan Back, Stacking 8 Per Stack with cushions removed, Velcro upholstered seat, Fire Retardant CA-117 Fabric Great for Catering Events

MSRP: \$250 EA. SELL: \$150 EA.

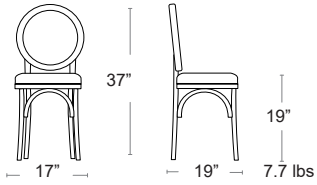

SIDE CHAIRS

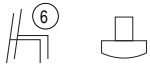

Tiberina

Uniformly coloured fiberglass and polypropylene with UV additives, Matte finish, Non-slip feet, Recyclable resin.

MSRP: \$210 EA. SELL: \$160 EA.



SIDE CHAIRS

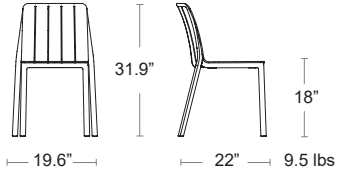

ANTRACITE
*S-NAR-40206.02



TORTORA
*S-NAR-40206.10



CORDA
*S-NAR-40206.24



TERRA
*S-NAR-40206.44



SIDE CHAIRS

SIDE CHAIRS



NARDI
YOUR OUTDOOR LIVING

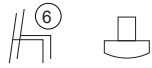

Bit

Uniformly coloured fiberglass and polypropylene with UV additives,
Matte finish, Non-slip feet, Recyclable resin

MSRP: \$210 EA. SELL: \$160 EA.

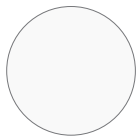
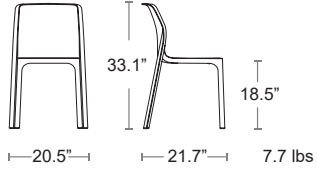

BIANCO
*S-NAR-40328.00

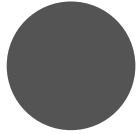

ANTRACITE
*S-NAR-40328.02



SALICE
*S-NAR-40328.04



TORTORA
*S-NAR-40328.10



SENAPE
*S-NAR-40328.56



CORALLO
*S-NAR-40328.75

SIDE CHAIRS



Doga

Uniformly coloured fiberglass and polypropylene with UV additives, Matte finish, Non-slip feet, Recyclable

MSRP: \$210 EA. SELL: \$160 EA.

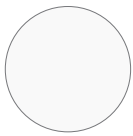
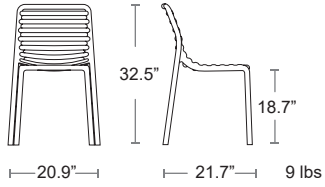

BIANCO
*S-NAR-40255.00

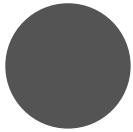

ANTRACITE
*S-NAR-40255.02



AGAVE
*S-NAR-40255.16



PERA
*S-NAR-40255.18



MARSALA
*S-NAR-40255.21



CAPPUCINO
*S-NAR-40255.14



MENTA
*S-NAR-40255.15



TABACCO
*S-NAR-40255.53



SIDE CHAIRS

SIDE CHAIRS

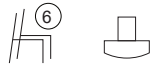

Trill

Uniformly coloured fiberglass and polypropylene with UV additives, Matte finish, Non-slip feet, Recyclable
See in stock cushions, Page 50

MSRP: \$210 EA. SELL: \$160 EA.

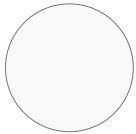
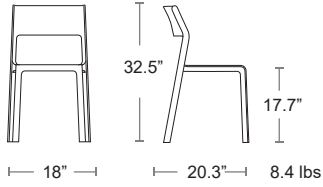

BIANCO
*S-NAR-40253.00



ANTRACITE
*S-NAR-40253.02



GRIGIO
*S-NAR-40253.03



TORTORA
*S-NAR-40253.10



AGAVE
*S-NAR-40253.16



OTTANIO
*S-NAR-40253.49



SENAPE
*S-NAR-40253.56



ROSA BOUQUET
*S-NAR-40253.08



TABACCO
*S-NAR-40253.53



SIDE CHAIRS

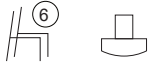



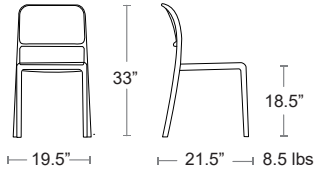

Riva

Uniformly coloured fiberglass and polypropylene with UV additives, Matte finish, Non-slip feet, Recyclable
See in stock cushions, Page 50

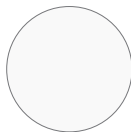
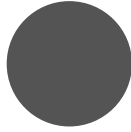
MSRP: \$190 EA. SELL: \$125 EA.

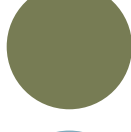

-  BIANCO
*S-NAR-40247.00
-  ANTRACITE
*S-NAR-40247.02
-  ROSSO
*S-NAR-40247.07
-  TORTORA
*S-NAR-40247.10
-  AGAVE
*S-NAR-40247.16
-  CELESTE
*S-NAR-40247.39



SIDE CHAIRS

SIDE CHAIRS



NARDI
YOUR OUTDOOR LIVING

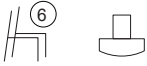

Bora

Uniformly coloured fiberglass and polypropylene with UV additives, Matte finish, Non-slip feet, Recyclable
See in stock cushions, Page 50

MSRP: \$190 EA. SELL: \$125 EA.

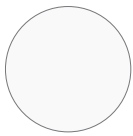
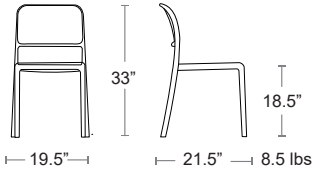

BIANCO
*S-NAR-40243.00



ANTRACITE
*S-NAR-40243.02



ROSSO
*S-NAR-40243.07



TORTORA
*S-NAR-40243.10



AGAVE
*S-NAR-40243.16



CELESTE
*S-NAR-40243.39

SIDE CHAIRS





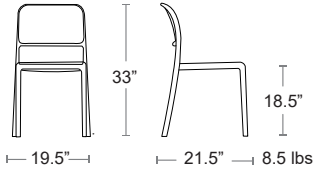

Costa

Uniformly coloured fiberglass and polypropylene with UV additives, Matte finish, Non-slip feet, Recyclable
See in stock cushions, Page 50

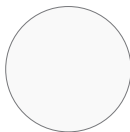
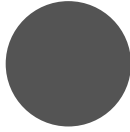
MSRP: \$190 EA. SELL: \$125 EA.



-  BIANCO
*S-NAR-40245.00
-  ANTRACITE
*S-NAR-40245.02
-  ROSSO
*S-NAR-40245.07
-  TORTORA
*S-NAR-40245.10
-  AGAVE
*S-NAR-40245.16
-  CELESTE
*S-NAR-40245.39



SIDE CHAIRS

SIDE CHAIRS



PAPATYA

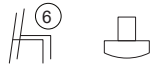

Varia

Stackable monobloc chair made of fiberglass reinforced polypropylene, With its simple clean lines it is suitable for all commercial applications, Anti UV stabilized.

MSRP: \$180 EA. SELL: \$120 EA.

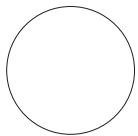
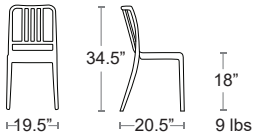

WHITE
*S-PPY-VARIA-01WHITE



RED
*S-PPY-VARIA-04RED



WARM GREY
*S-PPY-VARIA-17WARM GREY



ANTRACITE
*S-PPY-VARIA-22ANTRACITE



SIDE CHAIRS



Stack Mini Stool

Monobloc stool, Uniformly colored fiberglass polypropylene resins with UV additives, Matte finish, Non-slip feet. Recyclable

MSRP: \$160 EA. SELL: \$105 EA.

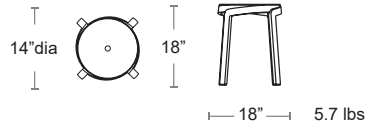

BASALTO
*S-NAR-40357.25

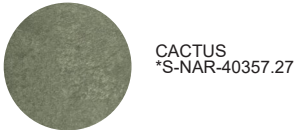

CACTUS
*S-NAR-40357.27



GESSO
*S-NAR-40357.29



TERRA
*S-NAR-40357.44



SIDE CHAIRS



SIDE CHAIRS

Side Chair Cushions

Fits Trill, Riva, Bora, Costa, Side Chairs
Zippered removable cover, washable, with ties

*C-BUM-GENERIC + COLOUR CODE

MSRP: \$70 EA. SELL: \$45 EA.

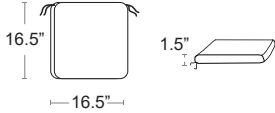

SIDE CHAIR CUSHIONS



SPECTRUM EGGSHELL
-48018

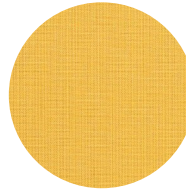

SPECTRUM DAFFODIL
-48024

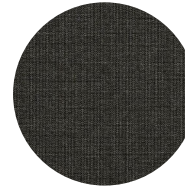

SPECTRUM CARBON
-48085

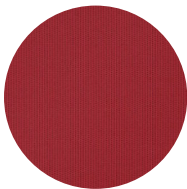

SPECTRUM CHERRY
-48096



CANVAS GRANITE
-5402

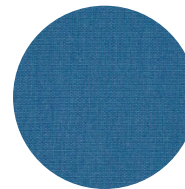

CANVAS REGATTA
-5493

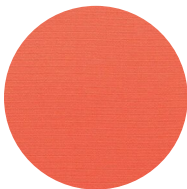

CANVAS MELON
-5415

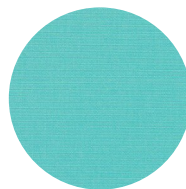

CANVAS ARUBA
-5416

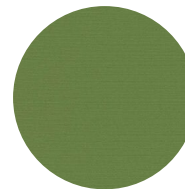

CANVAS PALM
-5421



DOLCE MANGO
-56000



DOLCE OASIS
-56001



PEYTON GRANITE
-56075



MILANO CHAR
-56079



CABANA REGATTA
-58029



CABANA CLASSIC
-58030

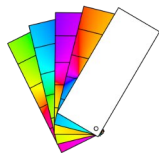

Custom Cushions & Special Orders

We can make cushions for all the chairs and stools we sell in available Sunbrella Fabric

We have swatches and samples of Special Order colours and fabrics.

Contact BUM for samples and pricing samplerrequest@bumoutdoor.ca

BAR STOOLS



BAR STOOLS

BAR STOOLS

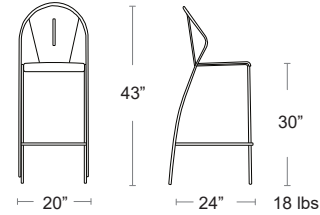
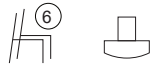

Code Bar or Counter

Tubular steel frame, Solid steel seat and back, E-Plated Powder Coat finish

MSRP: \$970 EA. SELL: \$630 EA.
ADD NET \$40 FOR COUNTER HEIGHT

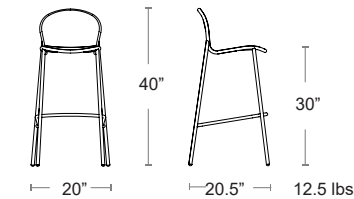
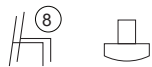

Ronda Bar or Counter

Tubular steel frame, Extended steel mesh seat and back, E-Plated Powder Coat finish

MSRP: \$900 EA. SELL: \$585 EA.
ADD NET \$40 FOR COUNTER HEIGHT

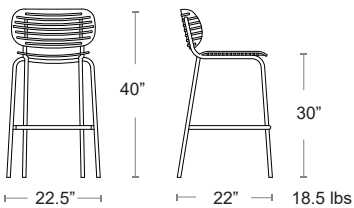
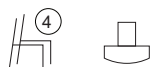
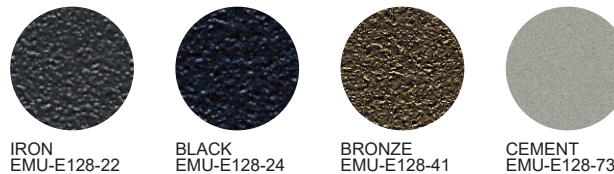

Mom Bar or Counter

Tubular steel frame, Steel slat seat and back, E-Plated Powder Coat finish

MSRP: \$900 EA. SELL: \$585 EA.
ADD NET \$40 FOR COUNTER HEIGHT

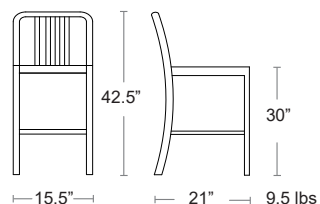

Anna

Square tubular aluminum frame, Solid aluminum seat and slat back, Brushed aluminum with lacquered clear coat

MSRP: \$840 EA SELL: \$545 EA



BAR STOOLS

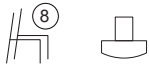

Ronda 2.0 Bar or Counter

Tubular steel frame, Extended steel mesh seat and back
E-Plated Powder Coat finish

MSRP: \$840 EA. SELL: \$545 EA.

ADD NET \$40 FOR COUNTER HEIGHT

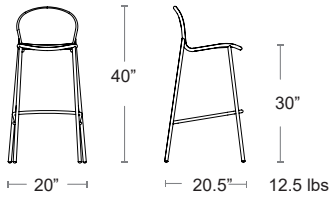

MARINE
BLUE
EMU-E460-16



IRON
EMU-E460-22



WHITE
EMU-E460-23

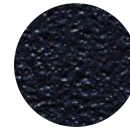

BLACK
EMU-E460-24



MAPLE
RED
EMU-E460-26



Star Bar or Counter

Tubular steel frame, Solid steel slat seat and back
E-Plated Powder Coat finish

MSRP: \$820 EA. SELL: \$535 EA.

ADD NET \$40 FOR COUNTER HEIGHT

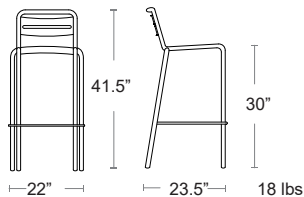

BRONZE
EMU-E164N-41



GREEN
EMU-E164N-60

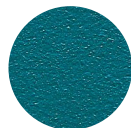

BLUE
EMU-E164N-61



Sid Bar or Counter

Square tubular aluminum frame, Wood-look aluminum slat seat and back,
E-Plated Powder Coat finish

MSRP: \$800 EA. SELL: \$520 EA.

ADD NET \$40 FOR COUNTER HEIGHT

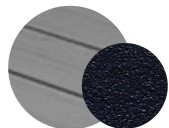
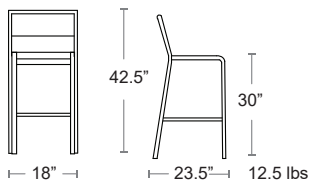

GREY/BLACK
EMU-AB1220-24-400



OAK/ALUM
EMU-AB1220-06-401

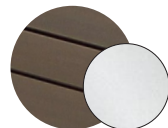

WENGE/ALUM
EMU-AB1220-06-402

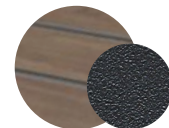

WALNUT/IRON
EMU-AB1220-22-404



Darwin Bar or Counter

Tubular steel frame, Steel mesh seat and back
E-Plated Powder Coat finish

MSRP: \$750 EA. SELL: \$490 EA.

ADD NET \$40 FOR COUNTER HEIGHT

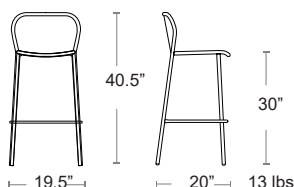

WHITE
EMU-E523-23



BLACK
EMU-E523-24



BRONZE
EMU-E523-41

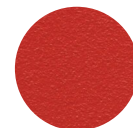

CHERRY
EMU-E523-50



CEMENT
EMU-E523-73



BAR STOOLS



emuamericas



Anna Backless Bar

Square tubular aluminum frame, Solid aluminum seat, Brushed aluminum with lacquered clear coat

MSRP: \$670 EA. SELL: \$435 EA.

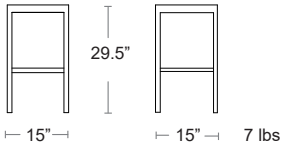

ALUMINUM
EMU-AB1206-06



emuamericas



Sid Backless Bar or Counter

Square tubular aluminum frame, Wood-look aluminum slat seat, E-Plated Powder Coat finish

MSRP: \$660 EA. SELL: \$430 EA.
ADD NET \$40 FOR COUNTER HEIGHT

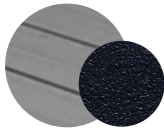
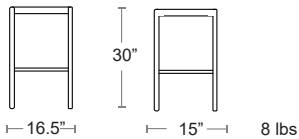

GREY/BLACK
EMU-AB1221-24-400



OAK/ALUM
EMU-AB1221-06-401

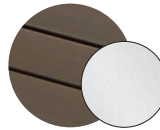

WENGE/ALUM
EMU-AB1221-06-402

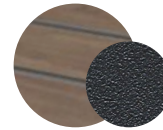

WALNUT/IRON
EMU-AB1221-22-404



BAR STOOLS



ReCLIPS

Stackable stools with plastic slats made from 97% recycled polypropylene + colour pigments + UV protection, clipped on an aluminum frame, E-Plated Powder Coat finish

MSRP: \$530 EA. SELL: \$345 EA.

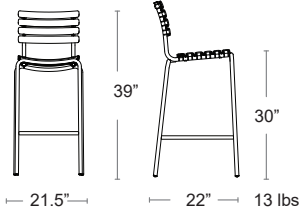

BLACK
*B-HOUE-22305-2024



BAR STOOLS



Capri

Black All Weather Rope back & arms. Antracite round tubular aluminum frame, E-Plated Powder Coat finish, Textaline seat cushion, Replaceable feet

MSRP: \$500 EA. **SELL: \$325 EA.**

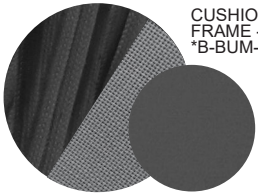
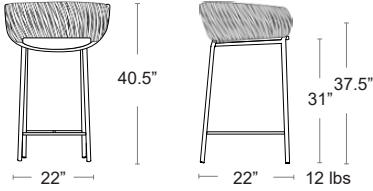

CUSHION - GREY
FRAME - BLACK
*B-BUM-CAPRI.BAR



BAR STOOLS

BAR STOOLS



Marco Sling Bar - Arm

Square tubular aluminum frame, E-Plated Powder Coat finish, Batyline Seat & Back, Polywood armrests

MSRP: \$470 EA. SELL: \$305 EA.

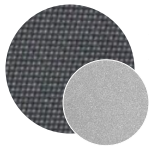
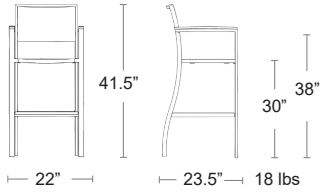

SEAT & BACK - BATYLINE
FRAME - SILVER
*B-MARCO-516B-BT-GS

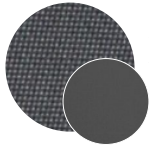

SEAT & BACK - BATYLINE
FRAME - ANTRACITE
*B-MARCO-516B-BT-GA



BAR STOOLS



Marco Polywood Bar - Arm

Square tubular aluminum frame, E-Plated Powder Coat finish, Polywood Seat, Back & Armrests

MSRP: \$470 EA. SELL: \$305 EA.

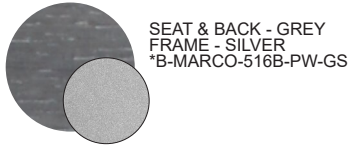
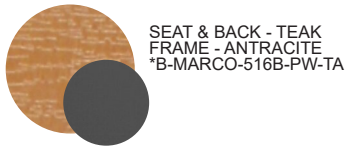
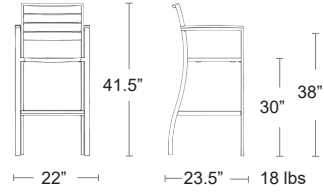

BAR STOOLS



Marco Wicker - Arm

Square tubular aluminum frame, E-Plated Powder Coat finish, Viro Wicker Seat & Back, Polywood armrests

MSRP: \$470 EA. SELL: \$305 EA.

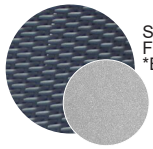
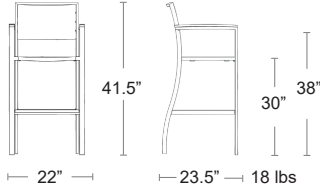

SEAT & BACK - VIRO GRAPHITE
FRAME - SILVER
*B-MARCO-516B-SW-BS



SEAT & BACK - VIRO GRAPHITE
FRAME - ANTRACITE
*B-MARCO-516B-SW-BA



BAR STOOLS



Adico 786B

Tubular steel frame, Solid steel seat and back, E-Plated Powder Coat finish

MSRP: \$450 EA. **SELL: \$295 EA.**

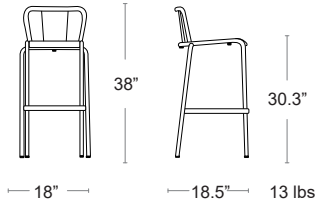
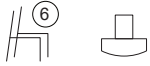

YELLOW
*B-ADC-786B-1002

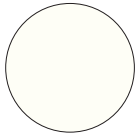

WHITE
*B-ADC-786B-1310



ORANGE
*B-ADC-786B-2012



RED
*B-ADC-786B-3169



GREEN
*B-ADC-786B-6021



BLUE
*B-ADC-786B-6034

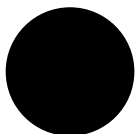

BLACK
*B-ADC-786B-9005



BAR STOOLS

BAR STOOLS



Parisian

All-welded Aluminum frame, wood-look E-Plated Powder Coat finish, with all weather wicker seat and back, replaceable feet.

MSRP: \$450 EA. SELL: \$295 EA.

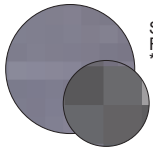
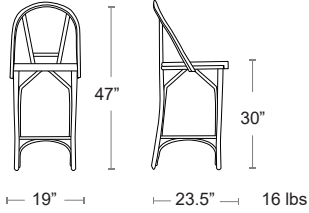

SEAT & BACK - BLACK & WHITE
FRAME - TEAK
*B-BUM-AC3531N17RAT



BAR STOOLS



Marco Sling Bar - Armless

Square tubular aluminum frame, E-Plated Powder Coat finish, Batyline Seat & Back

MSRP: \$420 EA. SELL: \$275 EA.

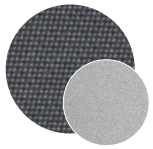
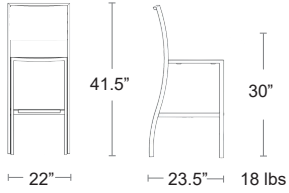

SEAT & BACK - BATYLINE
FRAME - SILVER
*B-MARCO-517B-BT-GS

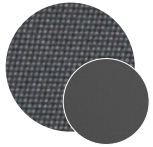

SEAT & BACK - BATYLINE
FRAME - ANTRACITE
*B-MARCO-517B-BT-GA



BAR STOOLS



Marco Polywood Bar - Armless

Square tubular aluminum frame, E-Plated Powder Coat finish, Polywood Seat & Back

MSRP: \$420 EA. SELL: \$275 EA.

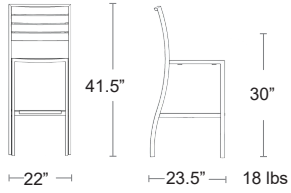

-  SEAT & BACK - TEAK
FRAME - ANTRACITE
*B-MARCO-517B-PW-TA
-  SEAT & BACK - GREY
FRAME - ANTRACITE
*B-MARCO-517B-PW-GA
-  SEAT & BACK - GREY
FRAME - SILVER
*B-MARCO-517B-PW-GS
-  SEAT & BACK - TEAK
FRAME - SILVER
*B-MARCO-517B-PW-TS



BAR STOOLS



Marco Wicker - Armless

Square tubular aluminum frame, E-Plated Powder Coat finish, Viro Wicker Seat & Back

MSRP: \$420 EA. SELL: \$275 EA.

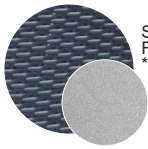
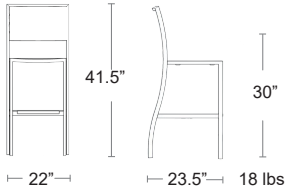

SEAT & BACK - VIRO GRAPHITE
FRAME - SILVER
*B-MARCO-517B-SW-BS



SEAT & BACK - VIRO GRAPHITE
FRAME - ANTRACITE
*B-MARCO-517B-SW-BA



BAR STOOLS

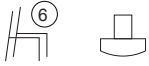

Net Bar

Uniformly coloured fiberglass and polypropylene with UV additives, Matte finish, Non-slip feet, Recyclable.

MSRP: \$270 EA. SELL: \$205 EA.

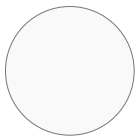
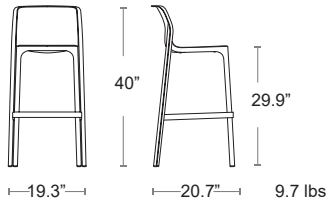

BIANCO
*B-NAR-40355.00

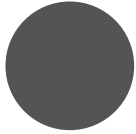

ANTRACITE
*B-NAR-40355.02



SALICE
*B-NAR-40355.04

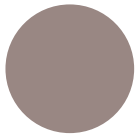

TORTORA
*B-NAR-40355.10



SENAPE
*B-NAR-40355.56



CORALLO
*B-NAR-40355.75



BAR STOOLS

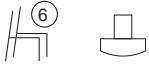

BAR STOOLS

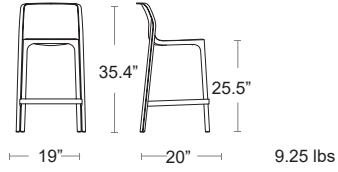

Net Counter

Uniformly coloured fiberglass and polypropylene with UV additives, Matte finish, Non-slip feet, Recyclable.

MSRP: \$270 EA **SELL: \$205 EA**

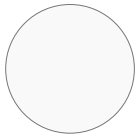

BIANCO
*B-NAR-40356.00

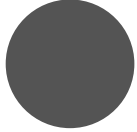

ANTRACITE
*B-NAR-40356.02



SALICE
*B-NAR-40356.04



TORTORA
*B-NAR-40356.10



SENAPE
*B-NAR-40356.56



CORALLO
*B-NAR-40356.75

BAR STOOLS

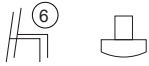

Doga Bar

Uniformly coloured fiberglass and polypropylene with UV additives, Matte finish, Non-slip feet, Recyclable

MSRP: \$270 EA. SELL: \$205 EA.

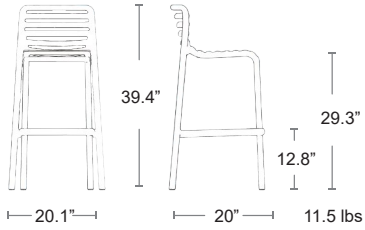

BAR STOOLS

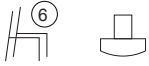

Trill Bar

Uniformly coloured fiberglass and polypropylene with UV additives, Matte finish, Non-slip feet, Recyclable resin

MSRP: \$270 EA. SELL: \$205 EA.

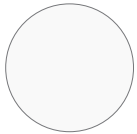
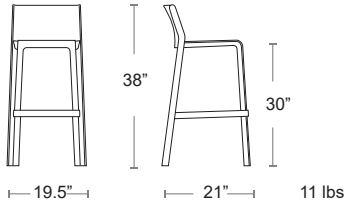

BIANCO
*B-NAR-40350.00



ANTRACITE
*B-NAR-40350.02



GRIGIO
*B-NAR-40350.03



TORTORA
*B-NAR-40350.10



AGAVE
*B-NAR-40350.16



OTTANIO
*B-NAR-40350.49



SENAPE
*B-NAR-40350.56



ROSA BOUQUET
*B-NAR-40350.08



TABACCO
*B-NAR-40350.53



BAR STOOLS







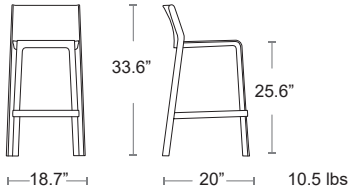

Trill Counter

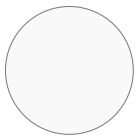
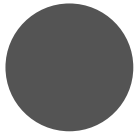
Uniformly coloured fiberglass and polypropylene with UV additives, Matte finish, Non-slip feet, Recyclable resin

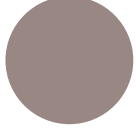
MSRP: \$270 EA SELL: \$205 EA

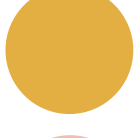
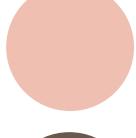

-  BIANCO
*B-NAR-40353.00
-  ANTRACITE
*B-NAR-40353.02
-  GRIGIO
*B-NAR-40353.03
-  TORTORA
*B-NAR-40353.10
-  AGAVE
*B-NAR-40353.16
-  OTTANIO
*B-NAR-40353.49
-  SENAPE
*B-NAR-40353.56
-  ROSA BOUQUET
*B-NAR-40353.08
-  TABACCO
*B-NAR-40353.53

BAR STOOLS

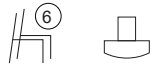

Lido Bar

Uniformly coloured fiberglass and polypropylene with UV additives, Perforated seat and back, Matte finish, Non-slip feet, Recyclable

MSRP: \$240 EA. SELL: \$155 EA.

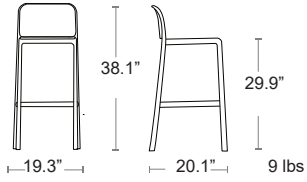

BAR STOOLS



NARDI
YOUR OUTDOOR LIVING

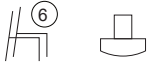

Lido Counter

Uniformly coloured fiberglass and polypropylene with UV additives,
Perforated seat and back, Matte finish, Non-slip feet, Recyclable

MSRP: \$240 EA. SELL: \$155 EA.

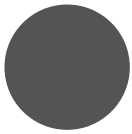
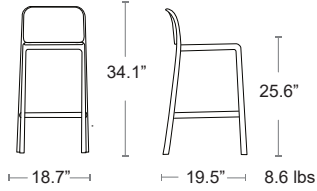

ANTRACITE
*B-NAR-40345.02



BAR STOOLS

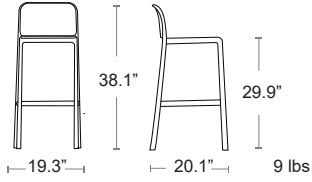
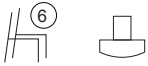





Faro Bar

Uniformly coloured fiberglass and polypropylene with UV additives, Solid seat and back, Matte finish, Non-slip feet, Recyclable

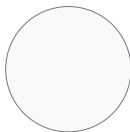
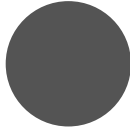
MSRP: \$240 EA. SELL: \$155 EA.



-  BIANCO
*B-NAR-40346.00
-  ANTRACITE
*B-NAR-40346.02
-  ROSSO
*B-NAR-40346.07
-  TORTORA
*B-NAR-40346.10
-  AGAVE
*B-NAR-40346.16
-  CELESTE
*B-NAR-40346.39

BAR STOOLS

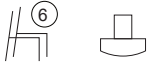

Faro Counter

Uniformly coloured fiberglass and polypropylene with UV additives, Solid seat and back, Matte finish, Non-slip feet, Recyclable

MSRP: \$240 EA. SELL: \$155 EA.

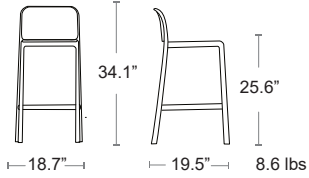

ANTRACITE
*B-NAR-40347.02



ROSSO
*B-NAR-40347.07



BAR STOOLS



Stack Maxi

Monobloc stool. Uniformly colored fiberglass polypropylene resins with UV additives, Matte finish, Non-slip feet, Recyclable

MSRP: \$230 EA. SELL: \$150 EA.

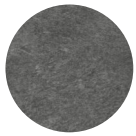
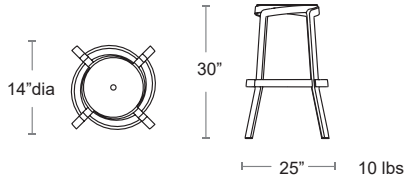
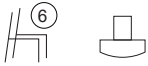

BASALTO
*B-NAR-40358.25

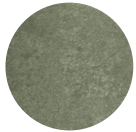

CACTUS
*B-NAR-40358.27



GESSO
*B-NAR-40358.29



TERRA
*B-NAR-40358.44



TABLES: DINING HEIGHT



TABLES: DINING HEIGHT



emuamericas

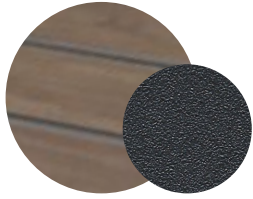

WALNUT TABLE & SEATS
IRON FINISH FRAME

Sid Picnic Tables

Aluminum wood-look table top and seat, aluminum frame and legs in Iron finish, Can be bolted down, Hardware not included

Sid Large ADA/AODA

MSRP: \$8000 EA. SELL: **\$5200 EA.**

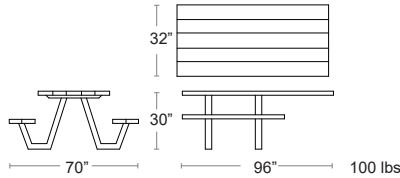

EMU-A1821A-22-404

Sid Large

MSRP: \$8000 EA. SELL: **\$5200 EA.**

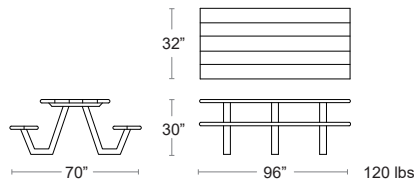

EMU-A1821-22-404

Sid Small

MSRP: \$7000 EA. SELL: **\$4550 EA.**

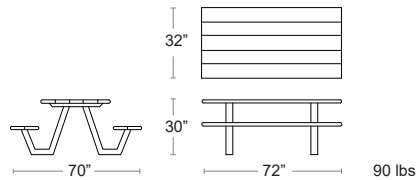

EMU-A1820-22-404

Cluster

MSRP: \$5800 EA. SELL: **\$3770 EA.**

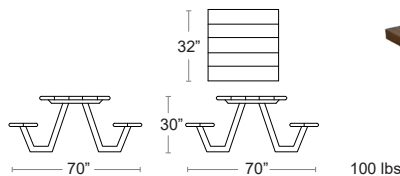

EMU-A1830-22-404

TABLES: DINING HEIGHT



Marco Polywood Round Cluster Seat

Round tubular steel frame, E-Plated Powder Coat finish, Polywood and Aluminum Seats and Tabletop, Seats 8, Can be bolted down, hardware included

MSRP: \$3200 EA. SELL: \$2080 EA.

TOP & SEATS GREY POLYWOOD
FRAME ANTRACITE
*T-BUM-CS-760-PW-GA

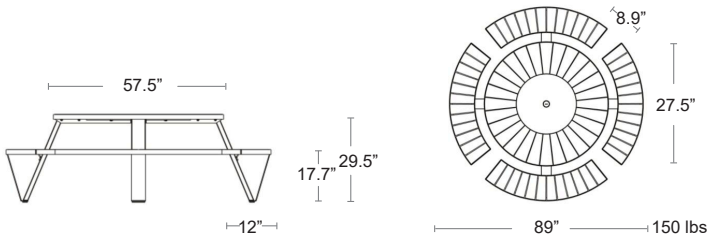
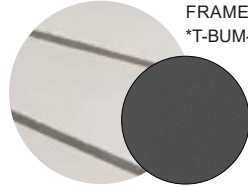

TABLES: DINING HEIGHT



Marco Polywood Cluster 4 Seat Table

Round tubular steel frame, E-Plated Powder Coat finish, Polywood and Aluminum Seats and Tabletop, No umbrella base required, Can be bolted down, hardware included

MSRP: \$2580 EA. SELL: \$1680 EA.

TOP & SEATS GREY POLYWOOD
FRAME ANTRACITE
*T-BUM-CS-7114-PW-GA

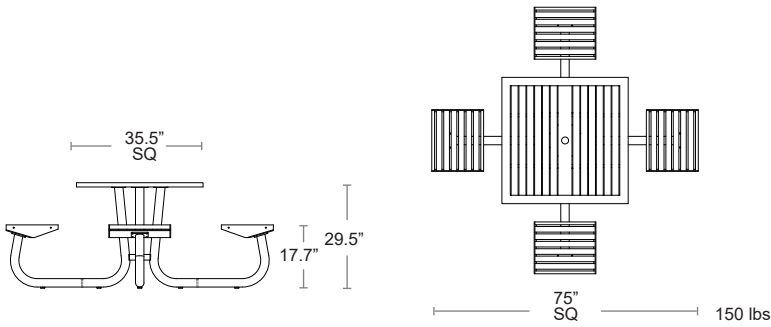
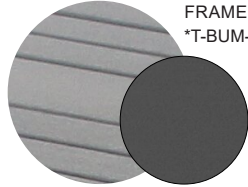

TABLES: DINING HEIGHT



Cluster 3 Seat ADA/AODA

Round tubular steel frame, E-Plated Powder Coat finish, Polywood and Aluminum Seats and Tabletop, No umbrella base required, Can be bolted down, hardware included

MSRP: \$2500 EA. SELL: \$1625 EA.

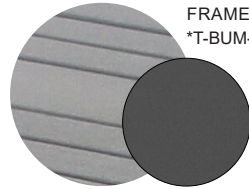

TOP & SEATS GREY POLYWOOD
FRAME ANTRACITE
*T-BUM-CS-7113-PW-GA-ADA

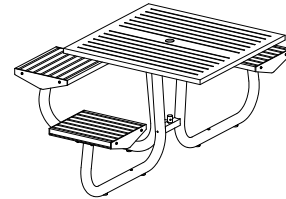
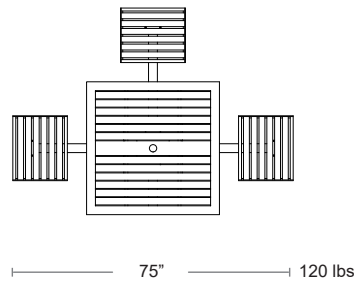
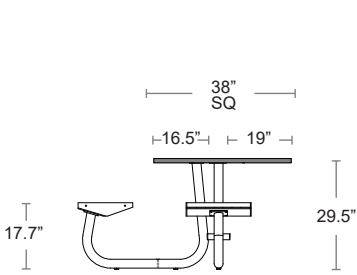

TABLES: DINING HEIGHT



Jakarta 72" Round Teak

Round table solid Teak construction
Teak will develop a warm gray patina over time or it can be oiled annually to maintain the look of new wood.

MSRP: \$3800 EA. SELL: \$2470 EA.

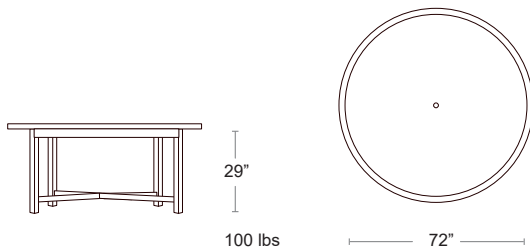

TABLES: DINING HEIGHT



emuamericas

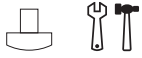

Sid Community Dining

Tubular aluminum frame,
Wood-look aluminum slat top,
E-Plated Powder Coat finish

MSRP: \$3250 EA.

SELL: \$2115 EA.

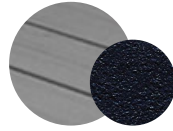
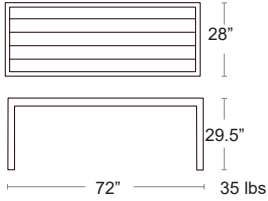

GREY/BLACK
EMU-A1549-24-400

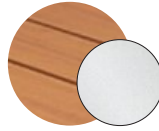

OAK/ALUM
EMU-A1549-06-401

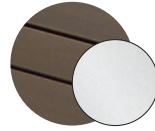

WENGE/ALUM
EMU-A1549-06-402

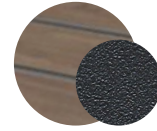

WALNUT/IRON
EMU-A1549-22-404



TABLES:
DINING HEIGHT

TABLES: DINING HEIGHT - EXTENDABLE



Rio 210 Aluminum Extendable Table

Tubular aluminum frame and legs, Aluminum top. E-Plated Powder Coat finish
Removable leaf with under table storage, UV Protected, Seats 8-10

MSRP: \$3210 EA. SELL: \$2410 EA.

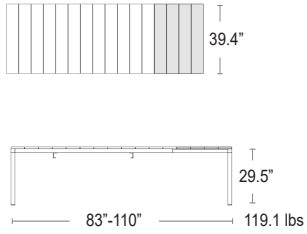

BIANCO
*T-NAR-48853.00

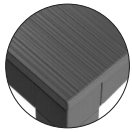

ANTRACITE
*T-NAR-48852.02

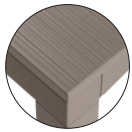

TORTORA
*T-NAR-48859.10

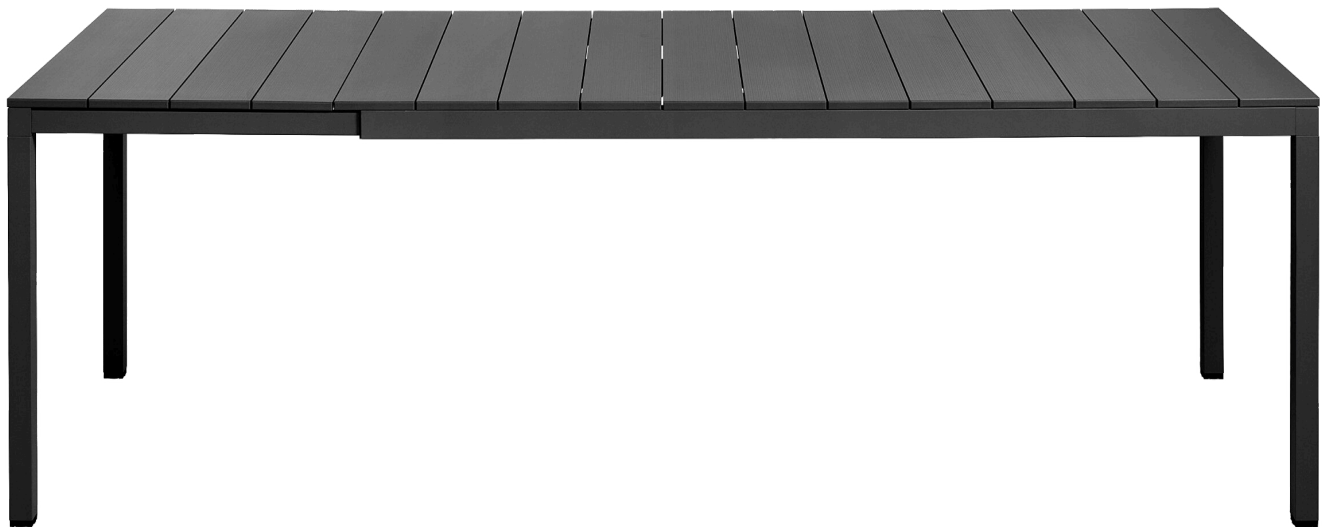

Panel Replacements

Specify End or Extension & Colour

RIO 210 Aluminum

*PT-NAR-204883

MSRP: \$490 EA. SELL: \$245 EA.

TABLES: DINING HEIGHT - EXTENDABLE



Rio 140 Aluminum Extendable Table

Tubular aluminum frame and legs, Aluminum top. E-Plated Powder Coat finish. Removable leaf with under table storage, UV Protected, Seats 6-8

MSRP: \$2430 EA. SELL: \$1825 EA.

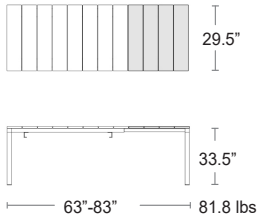

BIANCO
*T-NAR-48653.00.000 ALU RIO 140

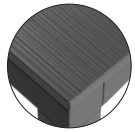

ANTRACITE
*T-NAR-48652.02.000 ALU RIO 140

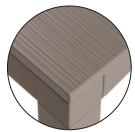

TORTORA
*T-Nar-48659.10.000 ALU RIO 140



Panel Replacements

Specify End or Extension & Colour

RIO 140 Aluminum

*PT-NAR-204863

MSRP: \$440 EA. SELL: \$220 EA.

TABLES: DINING HEIGHT - EXTENDABLE

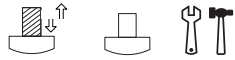

Tevere 210 Extendable Table

Top regenerated uniformly coloured fiberglass recyclable polypropylene resins, Frame coated aluminum, Matte finish, Seats 8-10

MSRP: \$2720 EA. SELL: \$2040 EA.

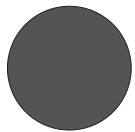
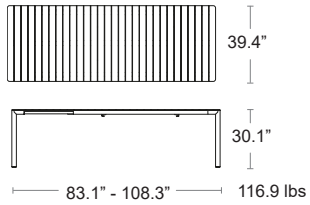

ANTRACITE
*T-NAR-49652.02



TORTORA
*T-NAR-49659.10



CORDA
*T-NAR-49669.24



TERRA
*T-NAR-49668.44



TABLES: DINING HEIGHT - EXTENDABLE



Tevere 147 Extendable Table

Top regenerated uniformly coloured fiberglass recyclable polypropylene resins, Frame coated aluminum, Matte finish, Seats 6-8

MSRP: \$2280 EA. SELL: \$1710 EA.

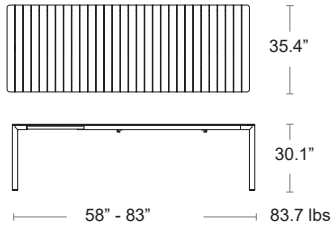

TABLES: DINING HEIGHT

TABLES: DINING HEIGHT - EXTENDABLE

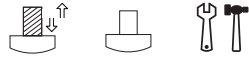

Rio 210 Resin Extendable Table

Tubular aluminum frame and legs, E-Plated Powder Coat finish, Resin top, Removable leaf with under table storage, UV Protected, Seats 8-10

MSRP: \$2100 EA. SELL: \$1575 EA.

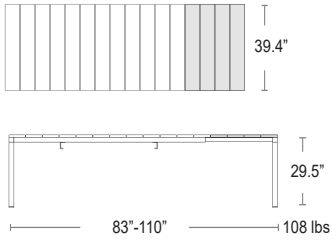

Panel Replacements

Specify End or Extension & Colour

RIO 210 Resin

*PT-NAR-204823

MSRP: \$210 EA. SELL: \$105 EA.

TABLES: DINING HEIGHT - EXTENDABLE



Rio 140 Resin Extendable Table

Tubular aluminum frame and legs, E-Plated Powder Coat finish, Resin top, Removable leaf with under table storage, UV Protected, Seats 6-8

MSRP: \$1730 EA. SELL: \$1300 EA.

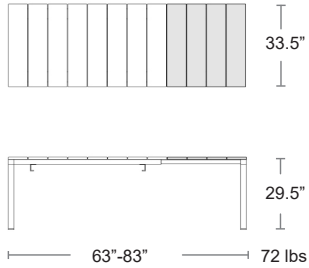

BIANCO
*T-NAR-48353.00

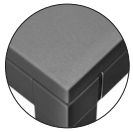

ANTRACITE
*T-NAR-48352.02



TORTORA
*T-NAR-48359.10

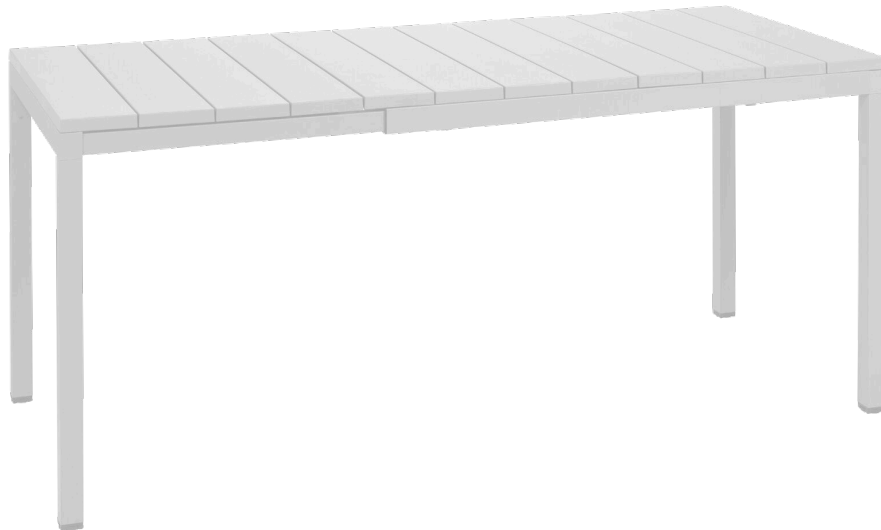

Panel Replacements

Specify End or Extension

RIO 140 Resin

*PT-NAR-204833

MSRP: \$200 EA. SELL: \$100 EA.

TABLES: DINING HEIGHT



Rio Bench ALU

Aluminum frame and seat, E-Plated Powder Coat finish, Adjustable height feet

MSRP: \$940 EA. SELL: \$705 EA.

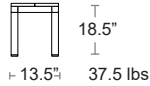
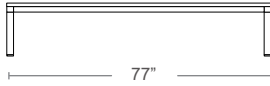
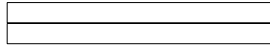

T
18.5"
↓



RIO BENCH ALU
BIANCO
*S-NAR-49053.00



RIO BENCH ALU
ANTRACITE
*S-NAR-49052.02



RIO BENCH ALU
TORTORA
*S-NAR-49059.10



TABLES: DINING HEIGHT - EXTENDABLE

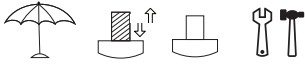

Libeccio Extendable Table

Resin Durel top, Tubular aluminum frame and legs, E-Plated Powder Coat finish, Removable leaf with under table storage, UV Protected, Umbrella hole 1.6"-1.9", Seats 6-8

MSRP: \$1200 EA. SELL: \$900 EA.

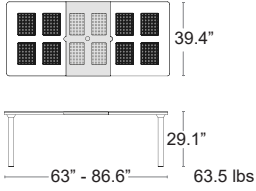

Panel Replacements

Specify End or Extension & Colour

*PT-NAR-204703 + COLOUR CODE

MSRP: \$200 EA. SELL: \$100 EA.

TABLES: DINING HEIGHT



Eclipse 87 x 40

Aluminum 5 slat top dining table with umbrella hole and plug,
All aluminum frame, E-Plated Powder Coat finish

MSRP: \$2960 EA. SELL: \$1925 EA.

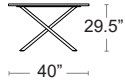
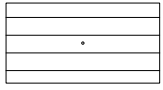

104 lbs



*T-BUM-EP-4086



TABLES: DINING HEIGHT



Star Square 40" ADA

Solid steel top, Tubular Steel legs, E-Plated Powder Coat finish

MSRP: \$2400 EA. SELL: \$1560 EA.

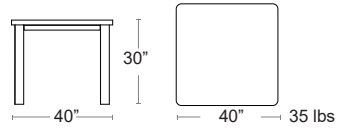

TABLES: DINING HEIGHT



Cambi Collection - Rectangular

Steel mesh tops, 1 1/4" thick, 1 9/16" Umbrella hole where available, Tubular steel legs, E-Plated Powder Coat finish, 3 Levelers and 1 Adjustable foot

Cambi ADA 48"x32"

EMU-E836 + COLOUR CODE

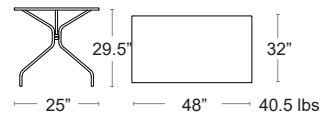

MSRP: \$1800 EA.
SELL: \$1170 EA.



Cambi 24"x32"

EMU-E834+ COLOUR CODE

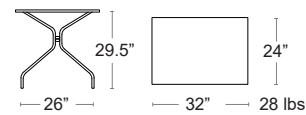

MSRP: \$1030 EA.
SELL: \$670 EA.



TABLES: DINING HEIGHT

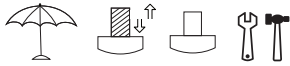

Cambi Collection Round

Steel mesh tops, 1 1/4" thick, 1 9/16" Umbrella hole where available, Tubular steel legs, E-Plated Powder Coat finish, 3 Levelers and 1 Adjustable foot

TABLES: DINING HEIGHT

Cambi 48"

EMU-E805 + COLOUR CODE

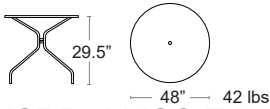

MSRP: \$1480 EA.
SELL: \$965 EA.

Cambi 42"

EMU-E804 + COLOUR CODE

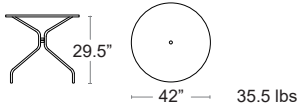

MSRP: \$1320 EA.
SELL: \$860 EA.

Cambi 36"

EMU-E813 + COLOUR CODE

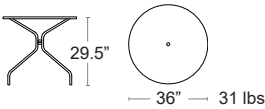

MSRP: \$1250 EA.
SELL: \$815 EA.

Cambi 32"

EMU-E803 + COLOUR CODE

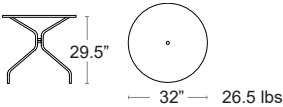

MSRP: \$1000 EA.
SELL: \$650 EA.



IRON
-22

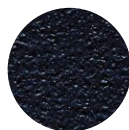

BLACK
-24



BRONZE
-41

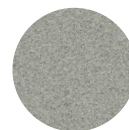

CEMENT
-73

TABLES: DINING HEIGHT

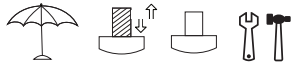

Cambi Square - Collection

Steel mesh tops, 1 1/4" thick, 1 9/16" Umbrella hole where available, Tubular steel legs, E-Plated Powder Coat finish, 3 Levelers and 1 Adjustable foot

Cambi 36"

EMU-E802 + COLOUR CODE

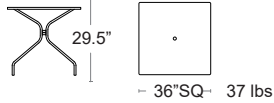

MSRP: \$1200 EA.

SELL: \$780 EA.

Cambi 32"

EMU-E801 + COLOUR CODE

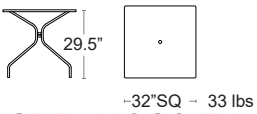

MSRP: \$1060 EA.

SELL: \$690 EA.

Cambi 24"

EMU-E800 + COLOUR CODE



MSRP: \$830 EA.

SELL: \$540 EA.



IRON
-22



BLACK
-24



BRONZE
-41

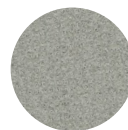

CEMENT
-73

TABLES: DINING HEIGHT

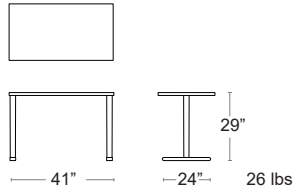
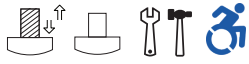

Darwin Dining ADA

Solid steel top, 3/4" thick, Cross steel weighted base, Tilt top, E-Plated Powder Coat finish, 3 Levelers and 1 Adjustable foot

MSRP: \$1800 EA. SELL: \$1170 EA.



BLACK
EMU-E3560-24

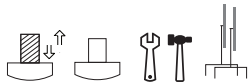

Darwin 32" Round

EMU-E849 + COLOUR CODE

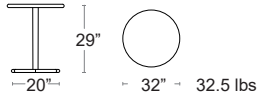

**MSRP: \$1090 EA.
SELL: \$710 EA.**

Darwin 24" Round

EMU-E848 + COLOUR CODE

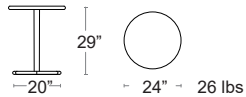

**MSRP: \$900 EA.
SELL: \$585 EA.**

Darwin 32" Square

EMU-E529 + COLOUR CODE

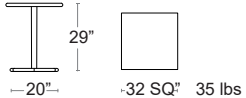

**MSRP: \$1360 EA.
SELL: \$885 EA.**

Darwin 28" Square

EMU-E525 + COLOUR CODE

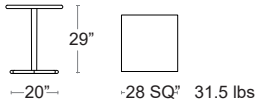

**MSRP: \$1120 EA.
SELL: \$730 EA.**

Darwin Tilt Collection

Solid steel top, 3/4" thick, Cross steel weighted base, Tilt top, E-Plated Powder Coat finish, 3 Levelers and 1 Adjustable foot,



WHITE
- 23



BLACK
- 24



BRONZE
- 41

TABLES: DINING HEIGHT



Bistro Collection

Solid steel top 3/4" thick, Trumpet steel weighted base, E-Plated Powder Coat finish

Bistro 32" Round

EMU-E902 + COLOUR CODE

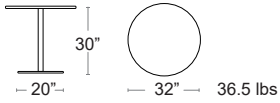

MSRP: \$1090 EA.
SELL: \$710 EA.

Bistro 24" Round

EMU-E900 + COLOUR CODE

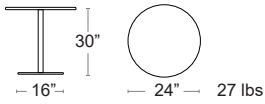

MSRP: \$890 EA.
SELL: \$580 EA.

Bistro 30" Square

EMU-E901 + COLOUR CODE

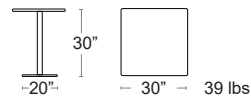

MSRP: \$1250 EA.
SELL: \$815 EA.



IRON
- 22



BRONZE
- 41



CEMENT
- 73



TABLES: DINING HEIGHT

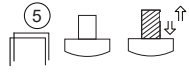

Adico 5028

Tubular Steel Base, E-Plated Powder Coat Finish, Okoume Marine Plywood Top
Industrial Clear Outdoor Epoxy, 2 leveler & 2 regular feet

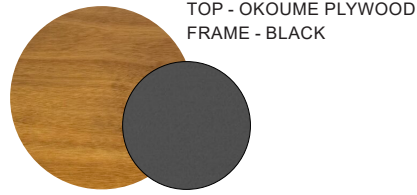

TOP - OKOUME PLYWOOD
FRAME - BLACK

Adico 55" x 28"

*T-ADC-5028-140X70RECT

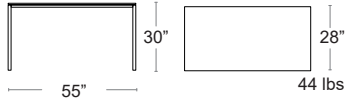

MSRP: \$1420 EA.
SELL: \$925 EA.



Adico 36" Square

*T-ADC-5028-90SQ

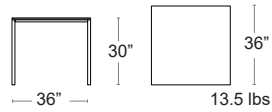

MSRP: \$990 EA.
SELL: \$645 EA.

Adico 28" Square

*T-ADC-5028-70SQ

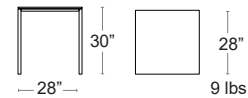

MSRP: \$590 EA.
SELL: \$385 EA.



TABLES: DINING HEIGHT

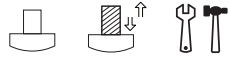

Marco Polywood Tables

Square tubular aluminum frame E-Plated Powder Coat finish, Polywood tabletop, An extra slat with the umbrella hole is included for tables with that option.

Marco 55" x 32"

*T-MARCO-DT516-55Q + COLOUR CODE

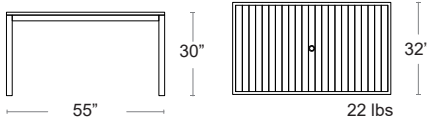

MSRP: \$940 EA.

SELL: \$610 EA.



Marco 48" x 32"

*T-MARCO-DT516-48Q + COLOUR CODE

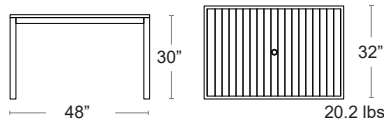

MSRP: \$820 EA.

SELL: \$535 EA.



Marco 24" x 32"

*T-MARCO-DT516-23Q + COLOUR CODE

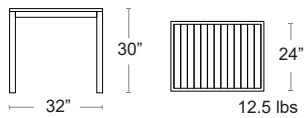

MSRP: \$560 EA.

SELL: \$365 EA.



TOP - TEAK
FRAME - ANTRACITE



TOP - GREY
FRAME - ANTRACITE

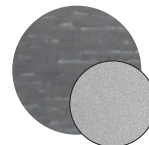

TOP - GREY
FRAME - SILVER

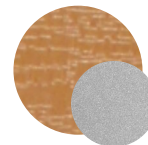

TOP - TEAK
FRAME - SILVER

TABLES: DINING HEIGHT

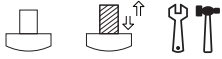

Marco Polywood Tables

Square tubular aluminum frame E-Plated Powder Coat finish, Polywood tabletop, An extra slat with the umbrella hole is included for tables with that option.

Marco 36" Square

*T-MARCO-DT516-36S + COLOUR CODE

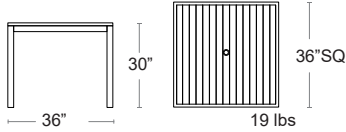

MSRP: \$760 EA.

SELL: \$495 EA.



Marco 32" Square

*T-MARCO-DT516-32S + COLOUR CODE

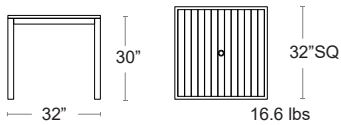

MSRP: \$680 EA.

SELL: \$445 EA.



TOP - TEAK
FRAME - ANTRACITE



TOP - GREY
FRAME - ANTRACITE

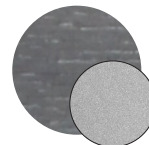

TOP - GREY
FRAME - SILVER

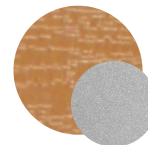

TOP - TEAK
FRAME - SILVER

TABLES: DINING HEIGHT

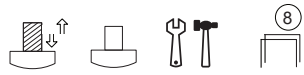

Cube Tables

Resin and fiberglass slat top, Tubular aluminum legs, E-Plated Powder Coat finish & UV Protected

Cube Rectangle



Cube 140

*T-NAR-47752.02

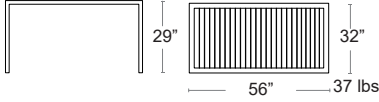

MSRP: \$780 EA.

SELL: \$510 EA.

Cube 120

*T-NAR-47652.02

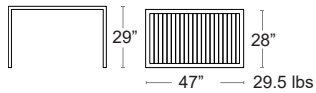

MSRP: \$700 EA.

SELL: \$455 EA.

Cube Square

Cube 80

*T-NAR-48052.02

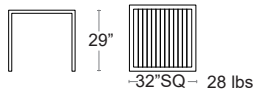

MSRP: \$540 EA.

SELL: \$365 EA.

Cube 70

*T-NAR-47852.02

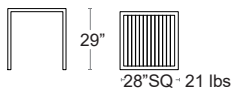

MSRP: \$500 EA.

SELL: \$325 EA.



SPECIAL ORDER

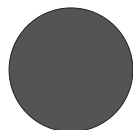

ANTRACITE
.02

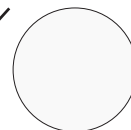

BIANCO
.00

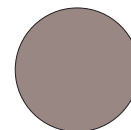

TORTORA
.10

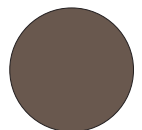

TABACCO
.53

TABLES: DINING HEIGHT



Combo

Table with center column and 4 spokes, Material: regenerated uniformly coloured fiberglass polypropylene resins with UV additives, Matte finish, Recyclable resin



Combo 70

*T-NAR-40032 + COLOUR CODE

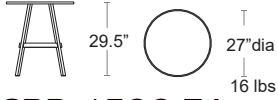

MSRP: \$500 EA.
SELL: \$325 EA.

Combo 60

*T-NAR-40030 + COLOUR CODE

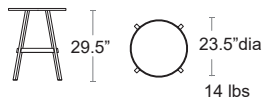

MSRP: \$440 EA.
SELL: \$285 EA.

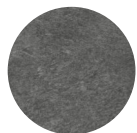

BASALTO
.25

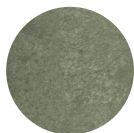

CACTUS
.27

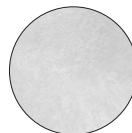

GESSO
.29

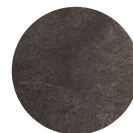

TERRA
.44



TABLES: DINING HEIGHT



Clip Dining

Resin and fiberglass perforated top, Tubular resin and fiberglass legs, UV Protected

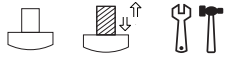

Clip 80

*T-NAR-40082 + COLOUR CODE

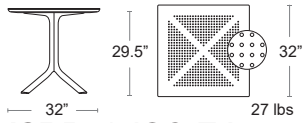

MSRP: \$480 EA.
SELL: \$315 EA.



Clip 70

*T-NAR-40084 + COLOUR CODE

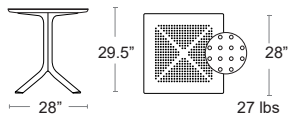

MSRP: \$460 EA.
SELL: \$300 EA.

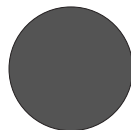

ANTRACITE
.02

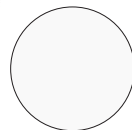

BIANCO
.00

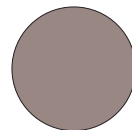

TORTORA
.10



AGAVE
.16

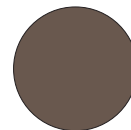

TABACCO
.53

TABLES: DINING HEIGHT



Spritz Table Dining & Lounge Height

Solid resin and fiberglass top with center column and three spokes, UV Protected,



MSRP: \$250 EA. SELL: \$190 EA.

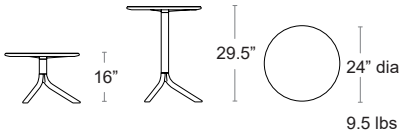

DINING



Includes removable stems for height variations



LOUNGE

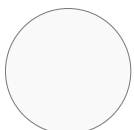

BIANCO
40058.
00

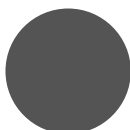

ANTRACITE
40058.
02



SALICE
40058.
04



ROSSO
40058.
07



TORTORA
40058.
10



AGAVE
40058.
16



CELESTE
40058.
39



SENAPE
40058.
56

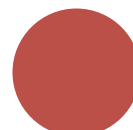

CORALLO
40058.
75

TABLES: BAR HEIGHT



TABLES: BAR HEIGHT



emuamericas

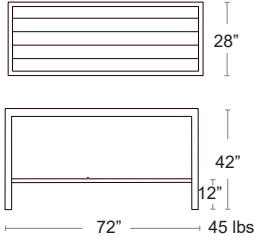
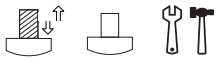

Sid Community Bar Table

Aluminum wood-look slats, Aluminum frame and legs, E-Plated Powder Coat finish

MSRP: \$3600 EA. SELL: \$2340 EA.

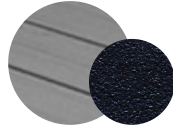

GREY/BLACK
EMU-A1550-24-400

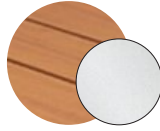

OAK/ALUM
EMU-A1550-06-401

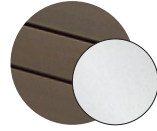

WENGE/ALUM
EMU-A1550-06-402

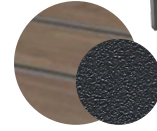

WALNUT/IRON
EMU-A1550-22-404



TABLES: BAR HEIGHT



Stone Ceramic Top Bar Table

All Aluminum Frame, E-Plated Powder Coat Finish
Ceramic Tabletop Surface

MSRP: \$1730 EA. **SELL: \$1125 EA.**

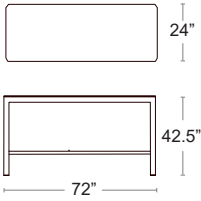

TOP - CERAMIC MARBLE
FRAME - BLACK
*T-BUM-CG-T-110CBC-BLACK

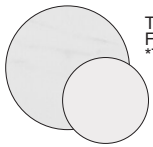

TOP - CERAMIC MARBLE
FRAME - WHITE
*T-BUM-CG-T-110CBC-WHITE



TABLES: BAR HEIGHT



Stone Ceramic Top Counter Table

All Aluminum Frame, E-Plated Powder Coat Finish
Ceramic Tabletop Surface

MSRP: \$1700 EA. **SELL: \$1100 EA.**

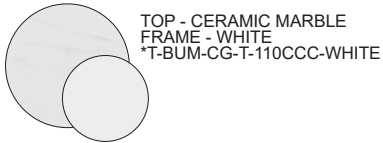
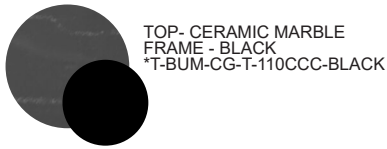
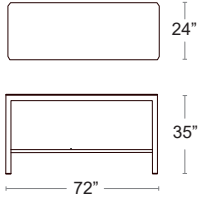

TABLES:
BAR HEIGHT

TABLES: BAR HEIGHT



Adico Bar Tables

Tubular Steel Base, E-Plated Powder Coat finish, Okoume Marine Plywood Top, Industrial Clear Outdoor Epoxy, 2 leveler & 2 regular feet

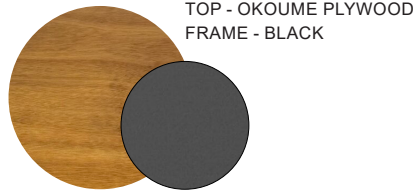

TOP - OKOUME PLYWOOD
FRAME - BLACK

Adico 55" x 28"

*T-ADC-IKA-A-140X70RECT

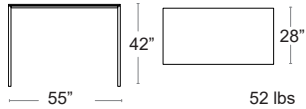

MSRP: \$1670 EA.
SELL: \$1085 EA.

Adico 55" x 24"

*T-ADC-IKA-A-140X60RECT

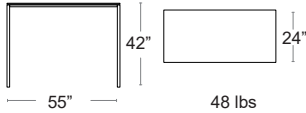

MSRP: \$1530 EA.
SELL: \$995 EA.

Adico 28" Square

*T-ADC-IKA-A-70SQ

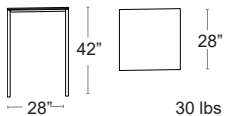

MSRP: \$960 EA.
SELL: \$625 EA.



TABLES: BAR HEIGHT

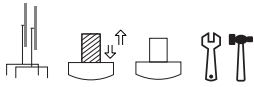

Darwin 32" Round

EMU-E540 + COLOUR CODE

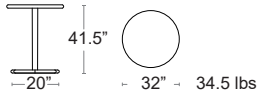

MSRP: \$1230 EA.
SELL: \$800 EA.

Darwin 24" Round

EMU-E539 + COLOUR CODE

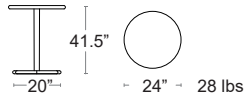

MSRP: \$1050 EA.
SELL: \$685 EA.

Darwin 28" Square

EMU-E528 + COLOUR CODE

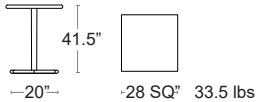

MSRP: \$1230 EA.
SELL: \$800 EA.

Darwin Tilt Collection

Solid steel top, 3/4" thick, Cross steel weighted base, Tilt top, E-Plated Powder Coat finish, 3 Levelers and 1 Adjustable foot



Bistro 32" Round

EMU-E902H + COLOUR CODE

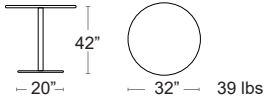

MSRP: \$1180 EA.
SELL: \$770 EA.

Bistro 24" Round

EMU-E900H + COLOUR CODE

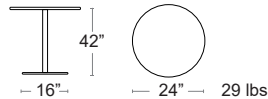

MSRP: \$1000 EA.
SELL: \$650 EA.

Bistro Collection

Solid steel top 3/4" thick, Trumpet steel weighted base, E-Plated Powder Coat finish



TABLES: BAR HEIGHT



Cambi 32"

Steel mesh top, 1 1/4" thick, Tubular steel legs, E-Plated Powder Coat finish, 3 Levelers and 1 Adjustable foot

MSRP: \$1090 EA. SELL: \$710 EA.

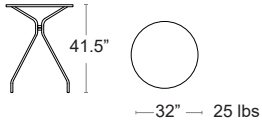

IRON
EMU-E820-22



BLACK
EMU-E820-24



BRONZE
EMU-E820-41



CEMENT
EMU-E820-73



TABLES: BAR HEIGHT

TABLES: BAR HEIGHT

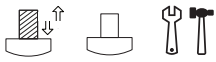

Cube Tables

Resin and fiberglass slat top, Tubular aluminum legs, E-Plated Powder Coat finish & UV Protected

Cube Rectangle



Cube 140

*T-NAR-47752.02+46952.02

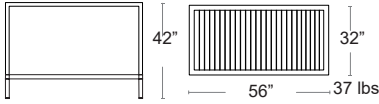

MSRP: \$1040 EA.

SELL: \$675 EA.

Cube 120

*T-NAR-47652.02+46852.02

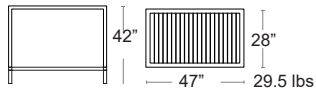

MSRP: \$950 EA.

SELL: \$645 EA.

Cube Square



Cube 80

*T-NAR-48052.02+48152.02

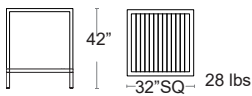

MSRP: \$770 EA.

SELL: \$525 EA.

Cube 70

*T-NAR-47852.02+47952.02

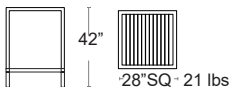

MSRP: \$730 EA.

SELL: \$490 EA.

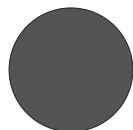

ANTRACITE
.02

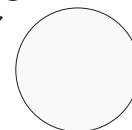

BIANCO
.00

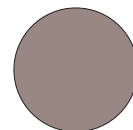

TORTORA
.10

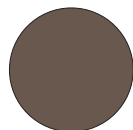

TABACCO
.53

TABLES: BAR HEIGHT



Combo Bar

Table with center column and 4 spokes. Material: regenerated uniformly colored fiberglass polypropylene resins with UV additives. Matt finish, Recyclable

Combo Bar 70

*T-NAR-40032 + 40031 + COLOUR CODE

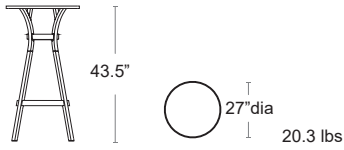

MSRP: \$650 EA.
SELL: \$440 EA.

Combo Bar 60

*7-NAR-40030 + 40031 + COLOUR CODE

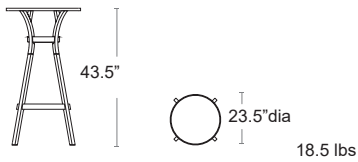

MSRP: \$580 EA.
SELL: \$390 EA.

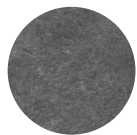

BASALTO
.25

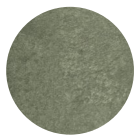

CACTUS
.27



GESO
.29

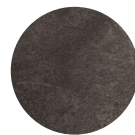

TERRA
44

EMU TABLETOPS & BASES



EMU TABLETOPS & BASES



Sid Tabletops

All Aluminum, 1.75" Thick, UV protected, Brushed border, Wood-look slats, E-Plated Powder Coat finish, Pre-drilled stainless steel inserts

Sid 48"x30", 22lbs
MSRP: \$1540 EA.
SELL: \$1000 EA.

Sid 26"x30", 12lbs
MSRP: \$900 EA.
SELL: \$585 EA.

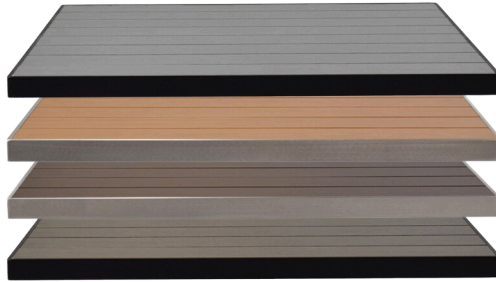

Sid Rectangle Tabletops

Sid 48"x30" Black/Grey EMU-A1495-24-400	Sid 26"x30" Black/Grey EMU-A1494-24-400
Sid 48"x30" Alum/Oak EMU-A1495-06-401	Sid 26"x30" Alum/Oak EMU-A1494-06-401
Sid 48"x30" Alum/Wenge EMU-A1495-06-402	Sid 26"x30" Alum/Wenge EMU-A1494-06-402
Sid 48"x30" Iron/Walnut EMU-A1495-22-404	Sid 26"x30" Iron/Walnut EMU-A1494-22-404

Sid 35" Dia., 12lbs
MSRP: \$1000 EA.
SELL: \$650 EA.

Sid 30" Dia., 10lbs
MSRP: \$760 EA.
SELL: \$495 EA.

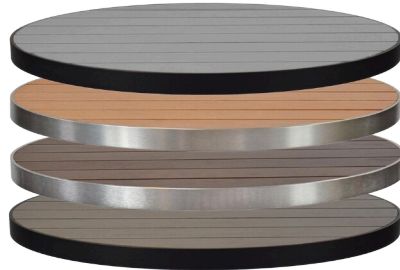

Sid Round Tabletops

Sid 35" Round Black/Grey EMU-A1482-24-400	Sid 30" Round Black/Grey EMU-A1481-24-400
Sid 35" Round Alum/Oak EMU-A1482-06-401	Sid 30" Round Alum/Oak EMU-A1481-06-401
Sid 35" Round Alum/Wenge EMU-A1482-06-402	Sid 30" Round Alum/Wenge EMU-A1481-06-402
Sid 35" Round Iron/Walnut EMU-A1482-22-404	Sid 30" Round Iron/Walnut EMU-A1481-22-404

Sid 35" Sq., 15lbs
MSRP: \$1160 EA.
SELL: \$755 EA.

Sid 30" Sq., 10lbs
MSRP: \$940 EA.
SELL: \$610 EA.

Sid 26" Sq., 10lbs
MSRP: \$800 EA.
SELL: \$520 EA.



Sid Square Tabletops

Sid 35" Sq. Black/Grey EMU-A1492-24-400	Sid 30" Sq. Black/Grey EMU-A1491-24-400	Sid 26" Sq. Black/Grey EMU-A1490-24-400
Sid 35" Sq. Alum/Oak EMU-A1492-06-401	Sid 30" Sq. Alum/Oak EMU-A1491-06-401	Sid 26" Sq. Alum/Oak EMU-A1490-06-401
Sid 35" Sq. Alum/Wenge EMU-A1492-06-402	Sid 30" Sq. Alum/Wenge EMU-A1491-06-402	Sid 26" Sq. Alum/Wenge EMU-A1490-06-402
Sid 35" Sq. Iron/Walnut EMU-A1492-22-404	Sid 30" Sq. Iron/Walnut EMU-A1491-22-404	Sid 26" Sq. Iron/Walnut EMU-A1490-22-404

Emu Tabletop & Base Fit Guide



SID TABLE TOPS		26"x30" EMU-A1494	48"x30" EMU-A1495	30" EMU-A1481	35" EMU-A1482	26" EMU-A1490	30" EMU-A1491	35" EMU-A1492
ZAK BASES	DINING EMU-A1361	★		★	★	★	★	
	DINING 5 PRONG EMU-A1362							★
	DOUBLE DINING EMU-A1363		★					
	BAR EMU-A1364	★		★		★	★	
	DOUBLE BAR EMU-A1365		★					

BUM COMMERCIAL FURNITURE will provide the necessary hardware if both top and base are purchased on the same Purchase Order.

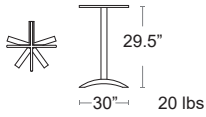
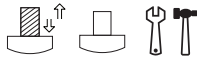

Zak Bases

Cast aluminum weighted base, E-Plated Powder Coat finish

Zak 5 Prong Dining

EMU-A1362 + COLOUR CODE

MSRP: \$750 EA.

SELL: **\$485 EA.**



Zak Double Dining

EMU-AB1363 + COLOUR CODE

MSRP: \$590 EA.

SELL: **\$385 EA.**

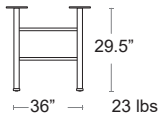

Zak Single Dining

EMU-A1361 + COLOUR CODE

MSRP: \$490 EA.

SELL: **\$320 EA.**

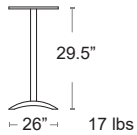

Zak Single Bar

EMU-A1364 + COLOUR CODE

MSRP: \$530 EA.

SELL: **\$345 EA.**

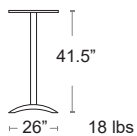

Zak Double Bar

EMU-AB1365 + COLOUR CODE

MSRP: \$670 EA.

SELL: **\$435 EA.**

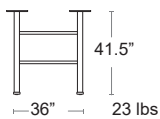

POLISHED ALUMINUM - 03



IRON - 22









BLACK - 24

TABLETOPS



Tabletop & Base Fit Guide

								
		24"x32"	48"x32"	32" Dia	30" Dia	24"	32"	36"
SINGLE DINING HEIGHT	FIORE DINING	★		★	★	★	★	
	FLUTE TILTING			★	★	★		
	FRASCA MAXI			★	★		★	★
	FRASCA MINI	★		★	★	★	★	
	IBISCO TILTING	★		★	★	★	★	
	TRAIL DINING 30							★
	TRAIL DINING 27	★		★	★	★	★	
	CLIP DINING	★		★	★	★	★	
DOUBLE DINING HEIGHT	SCUDO TILTING		★					
	TRAIL DINING DOUBLE		★					
SINGLE BAR HEIGHT	FIORE BAR	★		★	★	★		
	FRASCA TILTING	★		★	★	★		
	IBISCO TILTING	★		★	★	★		
	TRAIL BAR 30						★	★
	TRAIL BAR 27	★		★	★	★		
DOUBLE BAR HEIGHT	SCUDO DOUBLE TILTING		★					

**NARDI BASES CAN BE CUT DOWN FOR \$40 NET, SCUDO \$80 NET
TRAIL BASES CANNOT BE CUT**

BUM COMMERCIAL FURNITURE will provide the necessary hardware if both top and base are purchased on the same Purchase Order.



Jakarta Teak

Solid Natural Teak 1" Thick
8 pre-drilled stainless steel inserts to connect to Nardi table bases



T
1"
↓

	SIZE		WGT.	MSRP	SELL
*TT-BUM-TEAK 48X32	48"x32"		36 lbs	\$940	\$610
*TT-BUM-TEAK 24X32	24"x32"		17 lbs	\$560	\$365
*TT-BUM-TEAK 30RD	30"		15 lbs	\$500	\$325
*TT-BUM-TEAK 36SQ	36"		30 lbs	\$720	\$470
*TT-BUM-TEAK 32SQ	32"		23 lbs	\$610	\$400
*TT-BUM-TEAK 24SQ	24"		13 lbs	\$450	\$295

Teak will develop a warm gray patina over time or it can be oiled annually to maintain the look of new wood.





Bum Exteriolit Classic

Poplar veneer marine grade plywood board with 1/16" HPL coating on both sides, 1.2" thick, Moisture resistant, UV protected, Self tapping screws included

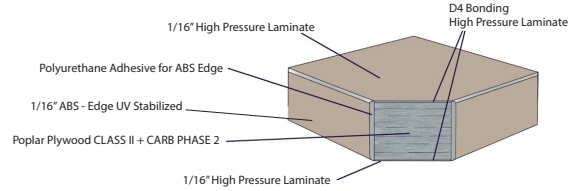

ATRIUM GREY	MARBLE CARRARA	MARBLE PIETRO	SILVER FABRIC	SIZE		WGT.	MSRP	SELL
*TT-SV-AG 48X32	*TT-SV-CM 48X32	*TT-SV-PM 48X32	*TT-SV-SF EX48X32	48"x32"		38 lbs	\$880	\$585
*TT-SV-AG 24X32	*TT-SV-CM 24X32	*TT-SV-PM 24X32	*TT-SV-SF EX24X32	24"x32"		19 lbs	\$450	\$300
*TT-SV-AG 30RD	*TT-SV-CM 30RD	*TT-SV-PM 30RD	*TT-SV-SF EX30RD	30"		20 lbs	\$580	\$380
*TT-SV-AG 36SQ	*TT-SV-CM 36SQ	*TT-SV-PM 36SQ	*TT-SV-SF EX36SQ	36"		32 lbs	\$630	\$410
*TT-SV-AG 32SQ	*TT-SV-CM 32SQ	*TT-SV-PM 32SQ	*TT-SV-SF EX32SQ	32"		25 lbs	\$610	\$400
*TT-SV-AG 24SQ	*TT-SV-CM 24SQ	*TT-SV-PM 24SQ	*TT-SV-SF EX24SQ	24"		14 lbs	\$350	\$230



SILVER FABRIC



MARBLE CARRARA

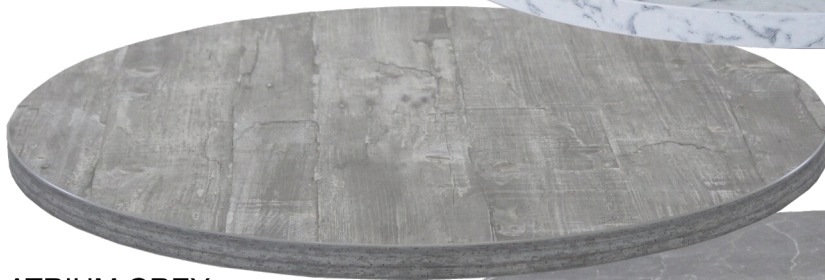

ATRIUM GREY



MARBLE PIETRO

TABLETOPS



Bum Compact HPL

High pressure laminate top, slightly textured to reduce sliding, 1/2" thick, UV protected
8 pre-drilled stainless steel inserts to connect to Nardi table bases

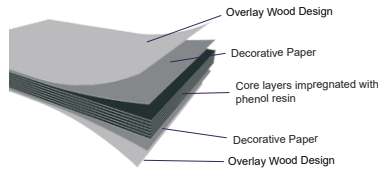

SILVER FABRIC	VINTAGE FLEETWOOD	VINTAGE PINE	SIZE		WGT.	MSRP	SELL
*TT-SV-SF 48X32	*TT-SV-VF 48X32	*TT-SV-VP 48X32	48"x32"		31 lbs	\$690	\$450
*TT-SV-SF 24X32	*TT-SV-VF 24X32	*TT-SV-VP 24X32	24"x32"		15 lbs	\$450	\$295
*TT-SV-SF 36SQ	*TT-SV-VF 36SQ	*TT-SV-VP 36SQ	36"		25 lbs	\$520	\$340
*TT-SV-SF 32SQ	*TT-SV-VF 32SQ	*TT-SV-VP 32SQ	32"		22 lbs	\$480	\$315
*TT-SV-SF 24SQ	*TT-SV-VF 24SQ	*TT-SV-VP 24SQ	24"		12 lbs	\$360	\$235

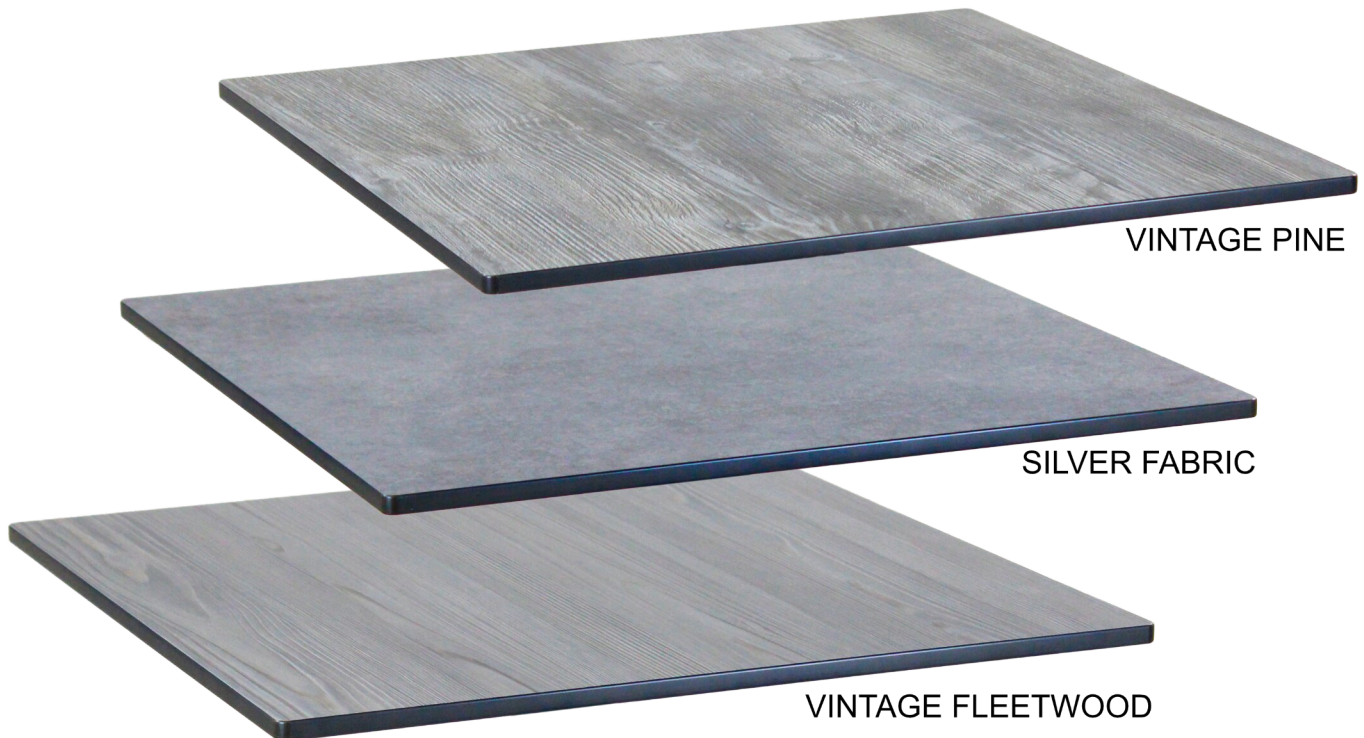

VINTAGE PINE

SILVER FABRIC

VINTAGE FLEETWOOD



Marco Polywood Tabletops

100% Polymer Polywood tabletop, 1" thick, moisture resistant, UV protected, Works with any table base that is size appropriate



1"
↓

POLYWOOD GREY	POLYWOOD TEAK	SIZE		WGT.	MSRP	SELL
*TT-MARCO- 48X32-GREY	*TT-MARCO- 48X32-TEAK	48"x32"		36 lbs	\$430	\$295
*TT-MARCO- 24X32-GREY	*TT-MARCO- 24X32-TEAK	24"x32"		17 lbs	\$270	\$190
*TT-MARCO- 36RD-GREY	*TT-MARCO- 36RD-TEAK	36"		20 lbs	\$320	\$220
*TT-MARCO- 36SQ-GREY	*TT-MARCO- 36SQ-TEAK	36" SQ		32 lbs	\$390	\$270
*TT-MARCO- 32SQ-GREY	*TT-MARCO- 32SQ-TEAK	32" SQ		23 lbs	\$320	\$210
*TT-MARCO- 24SQ-GREY	*TT-MARCO- 24SQ-TEAK	24" SQ		13 lbs	\$220	\$150

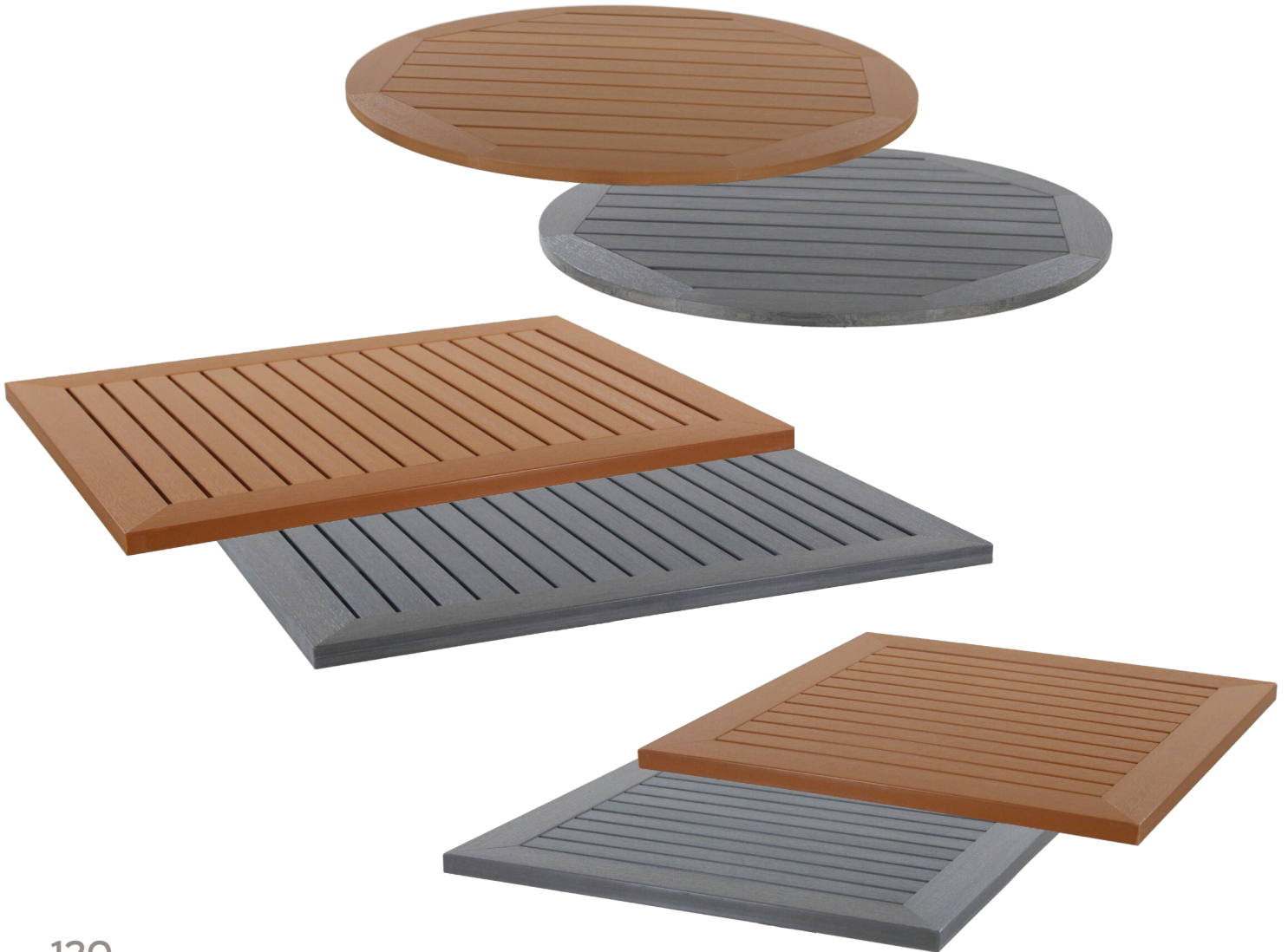

TABLETOPS



Bum Classic

Molded melamine mixed with redwood, 1" thick, UV protected
8 pre-drilled stainless steel inserts to connect to Nardi table bases

↑
1"
↓



ANTIQUE OAK	PINIE	PONDEROSA GREY	PONDEROSA WHITE	STRATTOS	WHITE	SIZE		WGT.	MSRP	SELL
*TT-SM-AO 48X32	*TT-SM-PN 48X32	*TT-SM-PG 48X32	*TT-SM-PW 48X32	*TT-SM-ST 48X32	*TT-SM-WH 48X32	48"x32"		36 lbs	\$450	\$295
*TT-SM-AO 24X32	*TT-SM-PN 24X32	*TT-SM-PG 24X32	*TT-SM-PW 24X32	*TT-SM-ST 24X32	*TT-SM-WH 24X32	24"x32"		17 lbs	\$330	\$215
*TT-SM-AO 32RD	*TT-SM-PN 32RD	*TT-SM-PG 32RD	*TT-SM-PW 32RD	*TT-SM-ST 32RD	*TT-SM-WH 32RD	32"		20 lbs	\$280	\$180
*TT-SM-AO 36SQ	*TT-SM-PN 36SQ	*TT-SM-PG 36SQ	*TT-SM-PW 36SQ	*TT-SM-ST 36SQ	*TT-SM-WH 36SQ	36"		32 lbs	\$400	\$260
*TT-SM-AO 32SQ	*TT-SM-PN 32SQ	*TT-SM-PG 32SQ	*TT-SM-PW 32SQ	*TT-SM-ST 32SQ	*TT-SM-WH 32SQ	32"		23 lbs	\$340	\$220
*TT-SM-AO 24SQ	*TT-SM-PN 24SQ	*TT-SM-PG 24SQ	*TT-SM-PW 24SQ	*TT-SM-ST 24SQ	*TT-SM-WH 24SQ	24"		13 lbs	\$220	\$145



ANTIQUE OAK

PINIE

PONDEROSA WHITE

PONDEROSA GREY

STRATTOS

WHITE

TABLETOPS

DINING HEIGHT BASES





Trail Self Leveling Bases

Say goodbye to wobbly tables!

These award-winning bases use a simple mechanical system with four pivoting legs that are interconnected in such a way that when a table is placed on an uneven surface the feet will move until all feet are stable, E Plated Powder Coat finish

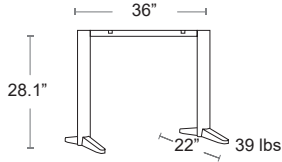

Trail Dining Double

*TB-NR-TTST22BK

MSRP: \$520 EA.

SELL: \$340 EA.

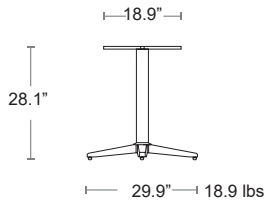

Trail Dining 30

*TB-NR-TRST30BK

MSRP: \$340 EA.

SELL: \$220 EA.

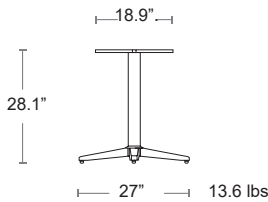

Trail Dining 27

*TB-NR-TRST27BK

MSRP: \$280 EA.

SELL: \$180 EA.



BLACK



NARDI:
DINING BASES

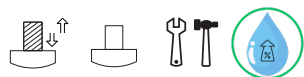

Scudo Tilt Double Dining

Cast Aluminum, E-Plated Powder Coat finish + Specially Treated for High Salinity Environments

MSRP: \$490 EA. SELL: \$320 EA.

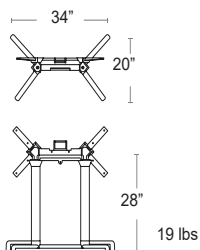

ANTRACITE
*TB-NAR-
54352.01

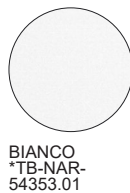

BIANCO
*TB-NAR-
54353.01



SILVER
*TB-NAR-
54354.01



TORTORA
*TB-NAR-
54359.01

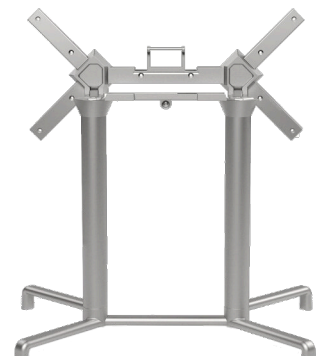



Frasca Maxi Dining

Cast Aluminum, E-Plated Powder Coat finish + Specially Treated for High Salinity Environments



*TB-NAR-536 + COLOUR CODE

MSRP: \$470 EA.
SELL: \$305 EA.

Frasca Mini Tilt Dining

Cast Aluminum, E-Plated Powder Coat finish + Specially Treated for High Salinity Environments

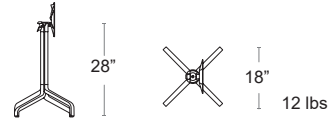

*TB-NAR-532 + COLOUR CODE

MSRP: \$340 EA.
SELL: \$220 EA.

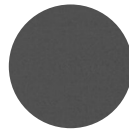

ANTRACITE
.52.01

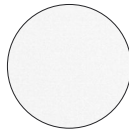

BIANCO
.53.01



TORTORA
.59.01



AGAVE
.66.01



TABACCO
.67.01



Ibisco Tilt Dining

Cast Aluminum, E-Plated Powder Coat finish + Specially Treated for High Salinity Environments, Tilt top

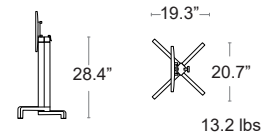

ANTRACITE
*TB-NAR-54552.01

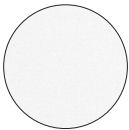

WHITE
*TB-NAR-54553.01

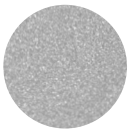

SILVER
*TB-NAR-54554.01

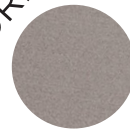

TORTORA
*TB-NAR-54559.01

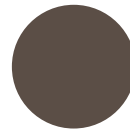

TABACCO
*TB-NAR-54567.01



Flute Tilt Dining

Cast Aluminum, E-Plated Powder Coat finish + Specially Treated for High Salinity Environments, Tilt top

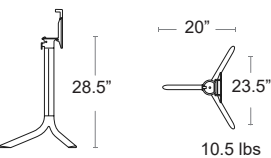

ANTRACITE
*TB-NAR-55652.01

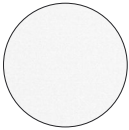

WHITE
*TB-NAR-55653.01

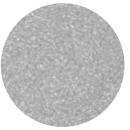

SILVER
*TB-NAR-55654.01

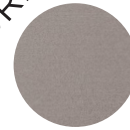

TORTORA
55659



DINING HEIGHT BASES

REFER TO TABLETOP & BASE FIT GUIDE, PAGE 116



Fiore Dining

Cast Aluminum, E-Plated Powder Coat finish +
Specially Treated for High Salinity Environments



MSRP: \$270 EA. SELL: \$175 EA.

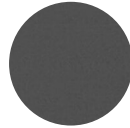
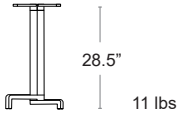
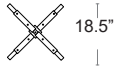

ANTRACITE
*TB-NAR-
53052.01

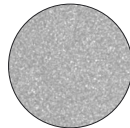

SILVER
*TB-NAR-
53054.01

SPECIAL ORDER

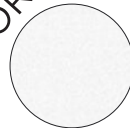

WHITE
*TB-NAR-
53053.01

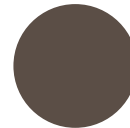

TABACCO
*TB-NAR-
53057.01

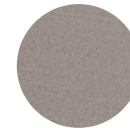

TORTORA
*TB-NAR-
53059.01



Clip Dining

Tubular resin and fiberglass legs, UV Protected

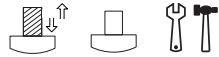

MSRP: \$230 EA. SELL: \$150 EA.

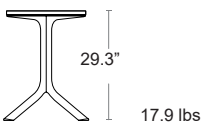
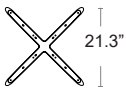

ANTRACITE
*TB-NAR-
40088.02

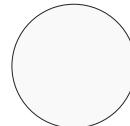

BIANCO
*TB-NAR-
40088.00



TORTORA
*TB-NAR-
40088.10

SPECIAL ORDER



AGAVE
*TB-NAR-
40088.16



TABACCO
*TB-NAR-
40088.53

**IF YOU DON'T SEE WHAT YOU WANT,
JUST ASK.**

**WE COLLABORATE
WITH FACTORIES WORLDWIDE
TO BRING YOUR VISION TO LIFE**

BAR HEIGHT BASES



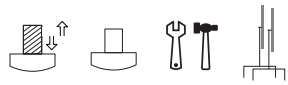

Scudo Tilt Double Bar

Cast Aluminum, E-Plated Powder Coat finish + Specially Treated for High Salinity Environments

MSRP: \$600 EA. SELL: \$390 EA.

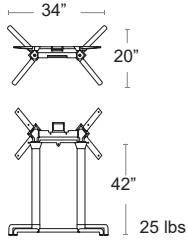

Trail Self Leveling Bases

Say goodbye to wobbly tables!

These award-winning bases use a simple mechanical system with four pivoting legs that are interconnected in such a way that when a table is placed on an uneven surface the feet will move until all feet are stable. E-Plated Powder Coat finish

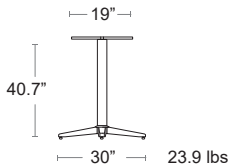

Trail Bar 30

*TB-NR-TRST30BKB

MSRP: \$380 EA.

SELL: \$250 EA.

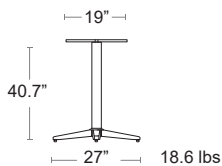

Trail Bar 27

*TB-NR-TRST27BKB

MSRP: \$360 EA.

SELL: \$235 EA.



BLACK





Frasca Tilt Bar

Cast Aluminum, E-Plated Powder Coat finish + Specially Treated for High Salinity Environments

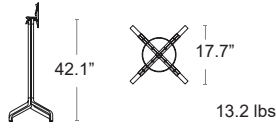

MSRP: \$390 EA. SELL: \$255 EA.

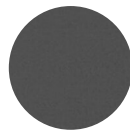

ANTRACITE
*TB-NAR-53452.01

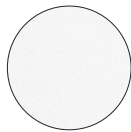

BIANCO
*TB-NAR-53453.01



AGAVE
*TB-NAR-53466.01

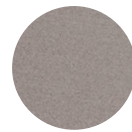

TORTORA
*TB-NAR-53459.01

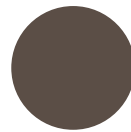

TABACCO
*TB-NAR-53467.01



Ibisco Tilt Bar

Cast Aluminum, Powder Coat + Specially Treated for High Salinity Environments

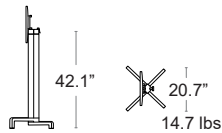

MSRP: \$370 EA. SELL: \$240 EA.

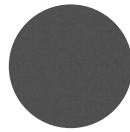

ANTRACITE
*TB-NAR-54652.01

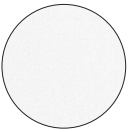

BIANCO
*TB-NAR-54653.01

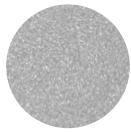

SILVER
*TB-NAR-54654.01



TORTORA
*TB-NAR-54659.01



TABACCO
*TB-NAR-54667.01

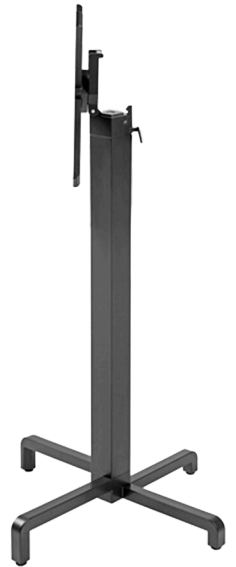

Fiore Bar

Cast Aluminum, E-Plated Powder Coat finish + Specially Treated for High Salinity Environments

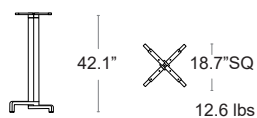

MSRP: \$320 EA. SELL: \$210 EA.

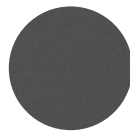

ANTRACITE
*TB-NAR-53152.01

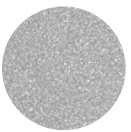

SILVER
*TB-NAR-53154.01

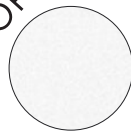

BIANCO
*TB-NAR-53153.01



TORTORA
*TB-NAR-53159.01



TABACCO
*TB-NAR-53157.01

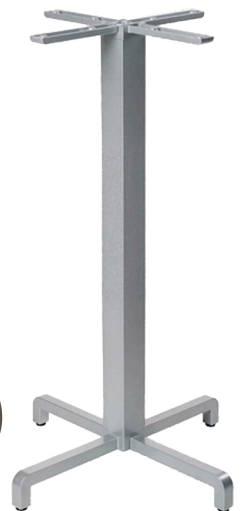

LOUNGE SEATING



LOUNGE SEATING

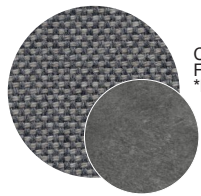
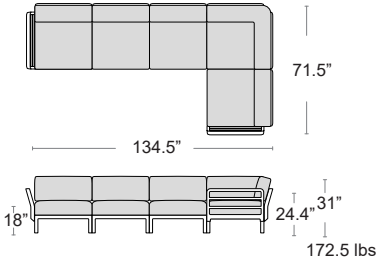

CUSHIONS - LAVA 215
FRAME - BASALTO.25
*L-NAR-40180.25.215

Maximo 5 Sofa Set

Uniformly coloured fiberglass and polypropylene with UV additives, Matte finish, Non-slip feet, Recyclable
The Nardi Regeneration industrial program is creating a line of outdoor furniture specifically dedicated to regenerated plastic products, made of post-industrial and post-consumer polypropylene, which can in turn be recycled

MSRP: \$7000 EA. SELL: \$4550 EA.

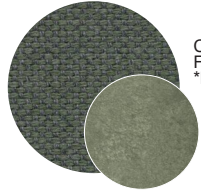

CUSHIONS - TIMO 217
FRAME - CACTUS 27
*L-NAR-40180.27.217

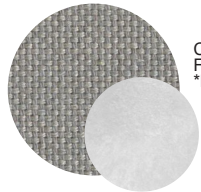

CUSHIONS - PERLA 213
FRAME - GESSO 29
*L-NAR-40180.29.213

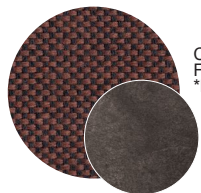

CUSHIONS -CANNELLA 219
FRAME - TERRA 44
*L-NAR-40180.44.219



LOUNGE SEATING

LOUNGE SEATING



Maximo Modular Deep Seating Collection

Maximo is an outdoor seating system of elements that can be connected as you see fit to suit your patio requirements.

Uniformly coloured fiberglass and polypropylene with UV additives, Matte finish, Non-slip feet, Recyclable

Using the components we stock you can make any of the chairs or sofas in the collection

CORNER MODULE

MSRP: \$1740 EA.

SELL: \$1130 EA.

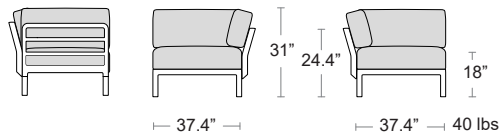

*L-NAR-40184.+ FRAME & FABRIC COLOUR CODES

ARMLESS MODULE

MSRP: \$1300 EA.

SELL: \$845 EA.

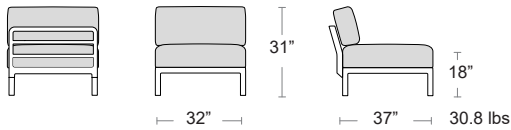

*L-NAR-40183.+ FRAME & FABRIC COLOUR CODES

POUF/OTTOMAN

MSRP: \$940 EA.

SELL: \$610 EA.

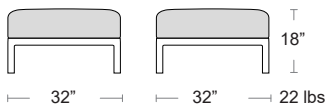

*L-NAR-40179.+ FRAME & FABRIC COLOUR CODES

COFFEE TABLE

MSRP: \$440 EA.

SELL: \$285 EA.

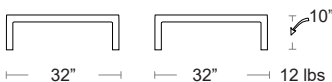

*L-NAR-40178.+ COLOUR CODE

LOUNGE SEATING

Curved Arm/Back

MSRP: \$170 EA.

SELL: \$110 EA.

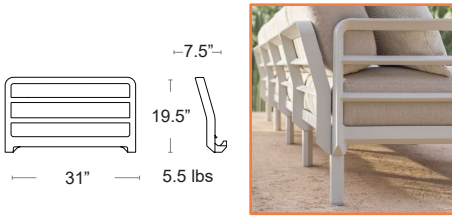

*L-NAR-40186.+ COLOUR CODE

Straight Arm/Back

MSRP: \$130 EA.

SELL: \$85 EA.

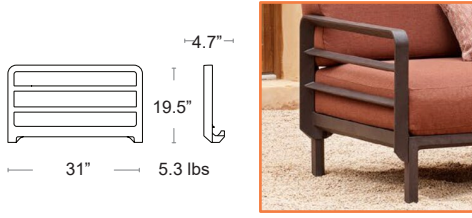

*L-NAR-40185.+ COLOUR CODE

Shelf Module

MSRP: \$120 EA.

SELL: \$80 EA.

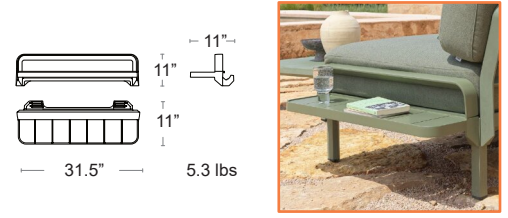

*L-NAR-40188.+ COLOUR CODE

Toss Pillow 19.5"x19.5"

*C-NAR-36180.01+COLOUR CODE

MSRP: \$180 EA. SELL: \$115 EA.



PERLA
.214



TIMO
.218



LAVA
.216



CANNELLA
.220

Bolster Pillow 24"x16"

*C-NAR-36180.02 + COLOUR CODE

MSRP: \$150 EA. SELL: \$95 EA.



PERLA
.214



LAVA
.216

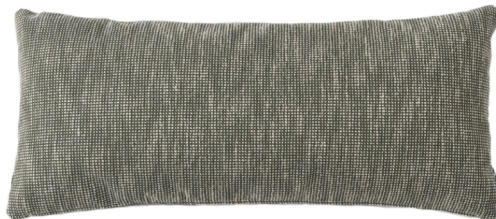

TIMO
.218



CANNELLA
.220

LOUNGE SEATING

Upholstery & Frame Colour Combinations.

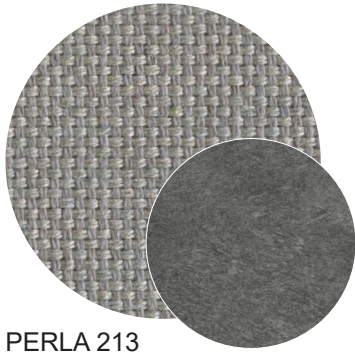

PERLA 213
BASALTO.25

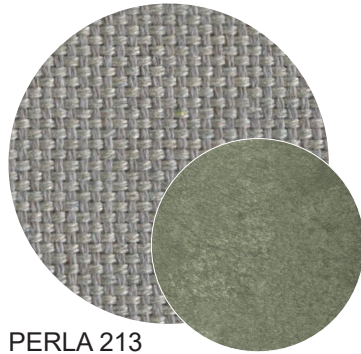

PERLA 213
CACTUS 27



PERLA 213
GESSO 29



PERLA 213
TERRA 44

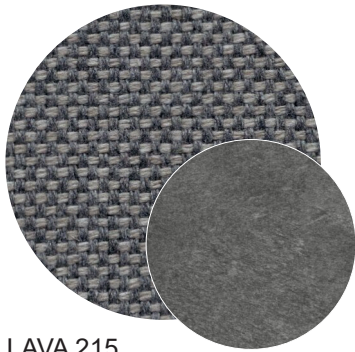

LAVA 215
BASALTO.25

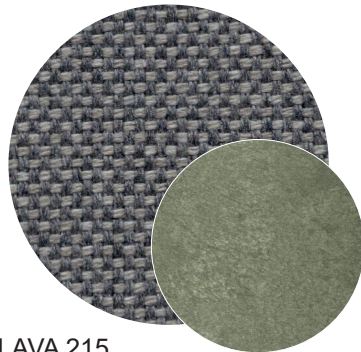

LAVA 215
CACTUS 27

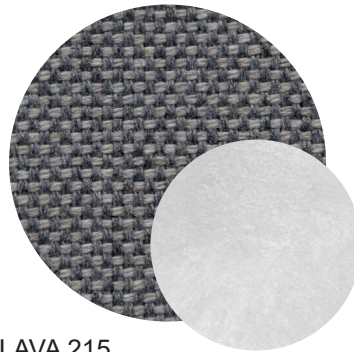

LAVA 215
GESSO 29

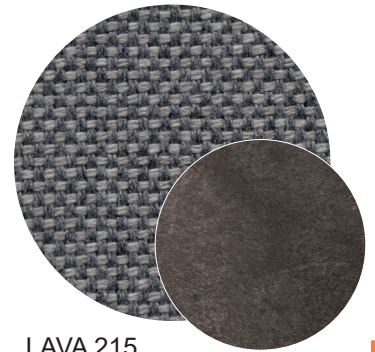

LAVA 215
TERRA 44

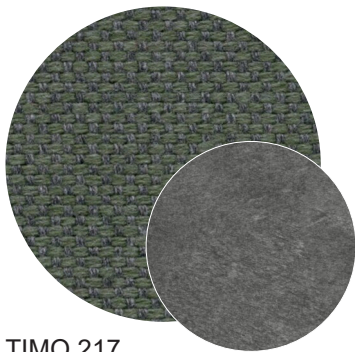

TIMO 217
BASALTO.25

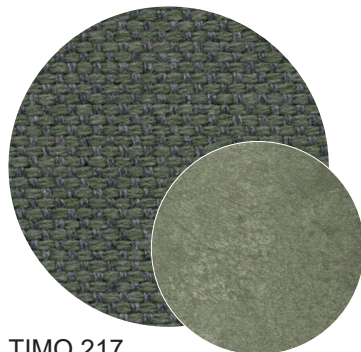

TIMO 217
CACTUS 27



TIMO 217
GESSO 29

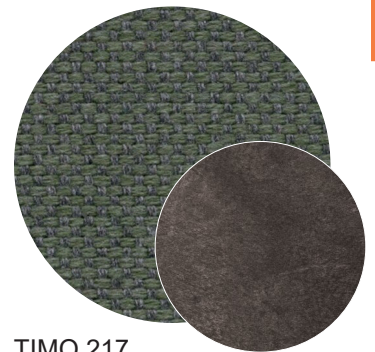

TIMO 217
TERRA 44

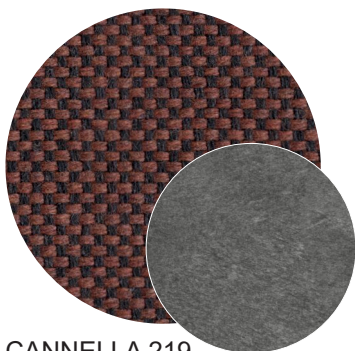

CANNELLA 219
BASALTO.25

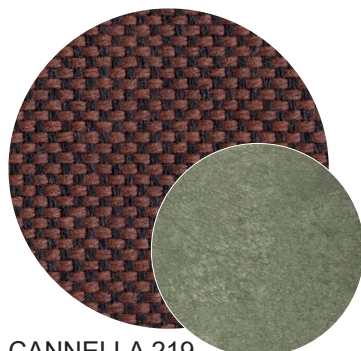

CANNELLA 219
CACTUS 27



CANNELLA 219
GESSO 29

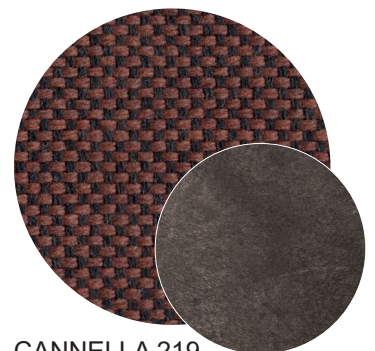

CANNELLA 219
TERRA 44

LOUNGE SEATING



Amalfi Collection

A modern take on a classic design made from high density polyethylene (HDPE), Very high impact resistance with a textured finish, UV protected
In stock cushions Sunbrella Cast Charcoal 40483-001, Special Order Sunbrella fabrics available for the same price, 8-12 weeks lead time required.

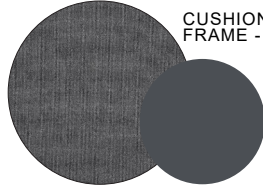
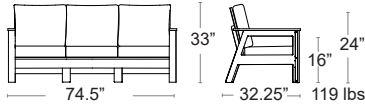

CUSHIONS - SUNBRELLA CAST CHARCOAL
FRAME - CHARCOAL

Sofa

MSRP: \$3100 EA. SELL: \$2015 EA.

*L-BUM-AMALFI SOFA



LOUNGE:
SEATING

LOUNGE SEATING

Loveseat

MSRP: \$2000 EA. SELL: \$1300 EA.

*L-BUM-AMALFI LOVE

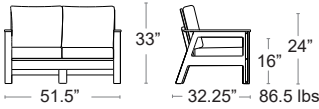

Club Chair

MSRP: \$1170 EA. SELL: \$760 EA.

*L-BUM-AMALFI CHAIR

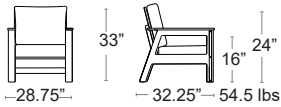



LOUNGE SEATING



REPLACEMENT CUSHIONS

Module	MSRP	SELL
Long Sofa O2L+O2R	\$2520	\$1640
Sofa 581	\$1890	\$1230
Love Seat 582	\$1320	\$860
Swivel Armchair 586	\$870	\$565
Recliner Armchair 511	\$870	\$565
Club Chair 583	\$870	\$565
Left O2L or Right O2R	\$1260	\$820
Corner OOC	\$1330	\$865
Double Armless O2A	\$1200	\$780
Armless OOA	\$690	\$450
Ottoman 508	\$360	\$235

City View Deep Seating Collection

E-Plated Powder Coat finish, welded Aluminum frame, sling seat and back for added comfort

Includes Sunbelievable cushions, zippered for easy cleaning

Replacement or Custom Colour cushions available

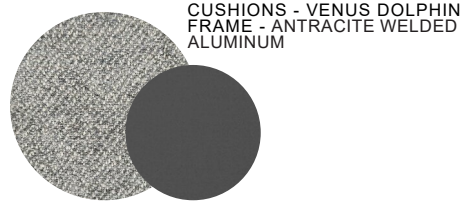

CUSHIONS - VENUS DOLPHIN
FRAME - ANTRACITE WELDED ALUMINUM

Sofa

MSRP: \$3150 EA. SELL: \$2050 EA.

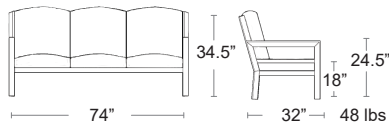

*L-BUM-CITYVIEW-581 SOFA

Love Seat

MSRP: \$2200 EA. SELL: \$1430 EA.

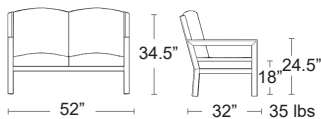

*L-BUM-CITYVIEW-582 LS

LOUNGE SEATING



Swivel Armchair
MSRP: \$1780 EA. **SELL: \$1160 EA.**



*L-BUM-CITYVIEW-586



Recliner High Back Armchair
MSRP: \$1600 EA. **SELL: \$1125 EA.**



*L-BUM-CITYVIEW-511

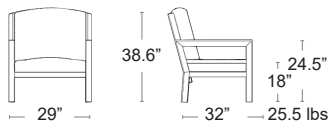

Club Chair
MSRP: \$1440 EA. **SELL: \$935 EA.**



*L-BUM-CITYVIEW-583 CLUB

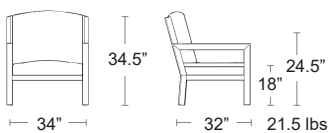

LOUNGE SEATING

City View Modular Collection

Long Sofa

MSRP: \$4200 EA. SELL: **\$2730 EA.**

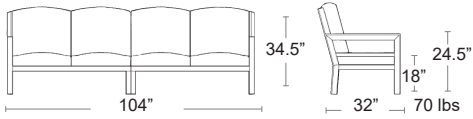

*L-BUM-CITYVIEW-02R+02L

Right or Left

MSRP: \$2100 EA. SELL: **\$1365 EA.**

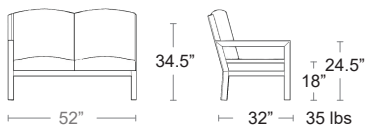

*L-BUM-CITYVIEW-02R



*L-BUM-CITYVIEW-02L

LOUNGE SEATING

Corner

MSRP: \$2220 EA. SELL: **\$1445 EA.**

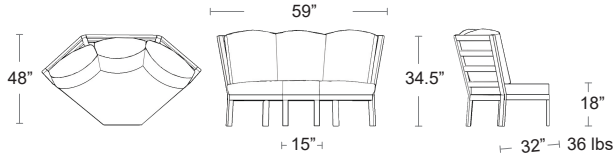

*L-BUM-CITYVIEW-00C



Double Armless

MSRP: \$1960 EA. SELL: **\$1275 EA.**

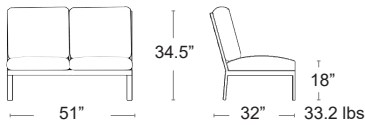

*L-BUM-CITYVIEW-02A



Slipper

MSRP: \$1140 EA. SELL: **\$740 EA.**

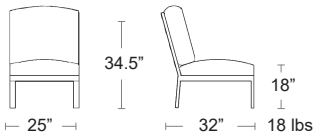

*L-BUM-CITYVIEW-00A



Ottoman

MSRP: \$600 EA. SELL: **\$390 EA.**

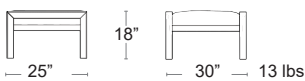

*L-BUM-CITYVIEW-508



LOUNGE SEATING



REPLACEMENT CUSHIONS		
Module	MSRP	SELL
Long Sofa	\$1800	\$900
Sofa SKY-581	\$1260	\$630
Love Seat SKY-582	\$900	\$450
Club Chair SKY-583	\$600	\$300
Left O2L14 or Right O2R14	\$900	\$450
Corner SKY-00C	\$600	\$300
Armless SKY-00A	\$470	\$235

Skyline Deep Seating Collection

All weather polyethylene wicker double fish bone weave, pattern for extra strength and durability, hand woven. Fully welded aluminum frame, E-Plated Powder Coat finish
Includes Sunbrella cushions, zippered for easy cleaning
Replacement or Custom Colour cushions available

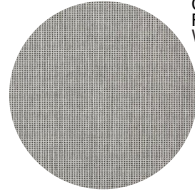

CUSHIONS - SUNBRELLA VOLT SILVER
FRAME - POLYETHYLENE ALL WEATHER
WICKER

SKY CUSHION BOX

MSRP: \$2000 EA. SELL: \$1300 EA.

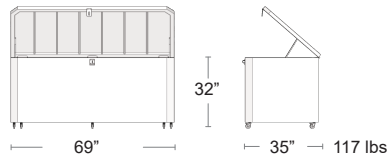

*L-BUM-SKY-BOX 2.0
CUSHIONS SOLD
SEPARATELY

SOFA

MSRP: \$2070 EA. SELL: \$1035 EA.

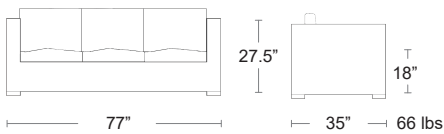

*@L-BUM-SKY-581

LOVE SEAT

MSRP: \$1500 EA. SELL: \$750 EA.

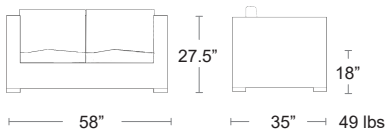

*@L-BUM-SKY-582

CLUB CHAIR

MSRP: \$1000 EA. SELL: \$500 EA.

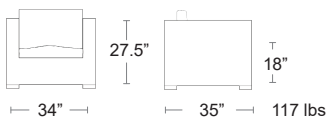

*@L-BUM-SKY-583

LOUNGE SEATING

Skyline Modular Collection

LONG SOFA

MSRP: \$3000 EA. SELL: \$1500 EA.

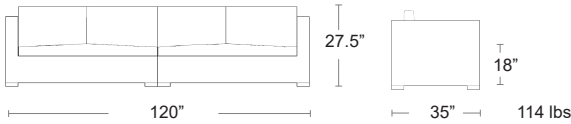

*@-L-BUM-SKY LONG

RIGHT & LEFT

MSRP: \$1500 EA. SELL: \$750 EA.

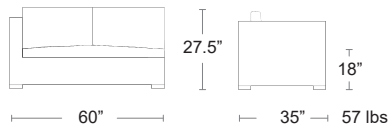

*@-L-BUM-SKY-02R14



*@-L-BUM-SKY-02L14

CORNER

MSRP: \$1000 EA. SELL: \$500 EA.

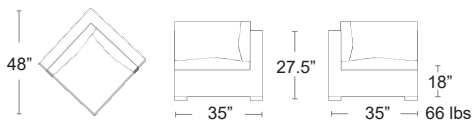

*@-L-BUM-SKY-00C

SLIPPER

MSRP: \$780 EA. SELL: \$390 EA.

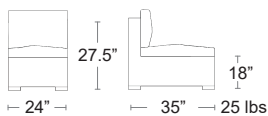

*@-L-BUM-SKY-00A

LOUNGE SEATING



REPLACEMENT CUSHIONS		
Module	MSRP	SELL
Sofa 581	\$1200	\$600
Love Seat 582	\$820	\$410
Club Chair 583	\$520	\$260
Long Sofa	\$1780	\$890
Left O2LM or Right O2RM	\$900	\$450
Corner O0CM	\$600	\$300
Armless O0AM	\$490	\$245

Urban Deep Seating Collection

Welded aluminum frame, E-Plated Powder Coat finish, sling seat and back for added comfort

Includes Sunbelievable cushions, zippered for easy cleaning
Replacement or Custom Colour cushions available

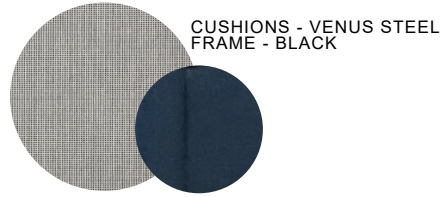

SOFA

MSRP: \$2000 EA. SELL: **\$1000 EA.**

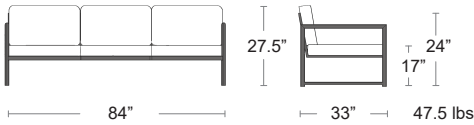

*L-BUM-URBAN-581

LOVE SEAT

MSRP: \$1370 EA. SELL: **\$685 EA.**

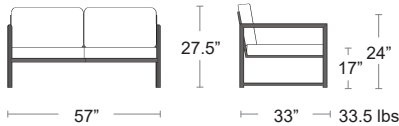

*L-BUM-URBAN-582

CLUB CHAIR

MSRP: \$860 EA. SELL: **\$430 EA.**

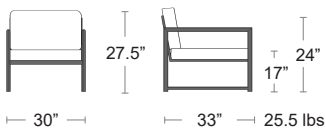

*L-BUM-URBAN-583

LOUNGE SEATING

Urban Modular Collection

LONG SOFA

MSRP: \$2970 EA. **SELL: \$1485 EA.**

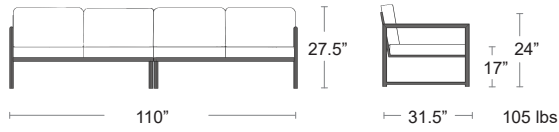

*L-BUM-URBAN- URBAN LONG

RIGHT & LEFT MODULE

MSRP: \$1500 EA. **SELL: \$750 EA.**

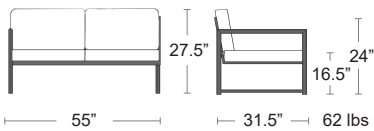

*L-BUM-URBAN-02RM



*L-BUM-URBAN-02LM

CORNER

MSRP: \$1000 EA. **SELL: \$500 EA.**

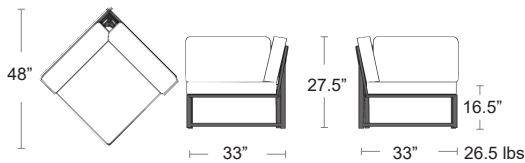

*L-BUM-URBAN-00CM

ARMLESS

MSRP: \$820 EA. **SELL: \$410 EA.**

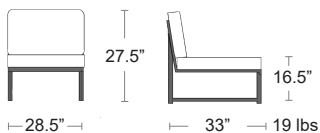

*L-BUM-URBAN-00AM

LOUNGE SEATING

LOUNGE SEATING



emuamericas

Lyla Collection

Aluminum frame with Synthetic rope back
Cushions included
Sunbrella Canvas Granite

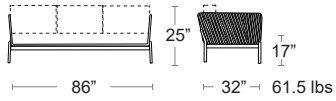

Lyla Sofa

EMU-A1732-04-12-CGR

MSRP: \$5850 EA.
SELL: \$3800 EA.



Lyla Club Chair

EMU-A1730-04-12-CGR

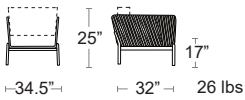

MSRP: \$2670 EA.
SELL: \$1735 EA.

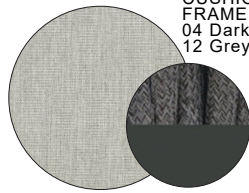

CUSHIONS - CANVAS GRANITE
FRAME
04 Dark Grey +
12 Grey Synthetic Rope



emuamericas

Mira Collection

Aluminum frame with Synthetic rope back
Cushions included
Sunbrella Canvas Haze

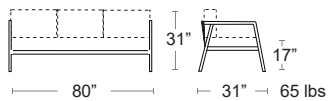

Mira Sofa

EMU-A1742-02-18-CHZ

MSRP: \$4850 EA.
SELL: \$3150 EA.

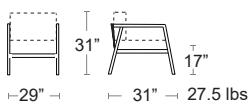

Mira Club Chair

EMU-A1740-02-18-CHZ

MSRP: \$2090 EA.
SELL: \$1360 EA.

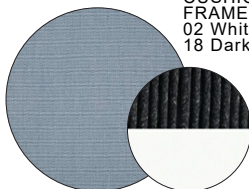

CUSHIONS - CANVAS HAZE
FRAME
02 White +
18 Dark Grey Synthetic Rope



LOUNGE SEATING



SERRALUNGA

Pine Beach Collection

Made from LLDPE (linear low-density polyethylene) by rotational molding. Suitable for outdoor use and all-weather resistant, small drain hole for water, UV protection, 100% recyclable material, solution dyed, Resistant to temperatures, minus 35°C plus 80°C.



Pine Beach Sofa

*L-SL-PINEBEA/SO-ANT

MSRP: \$3200 EA.

SELL: \$2080 EA.

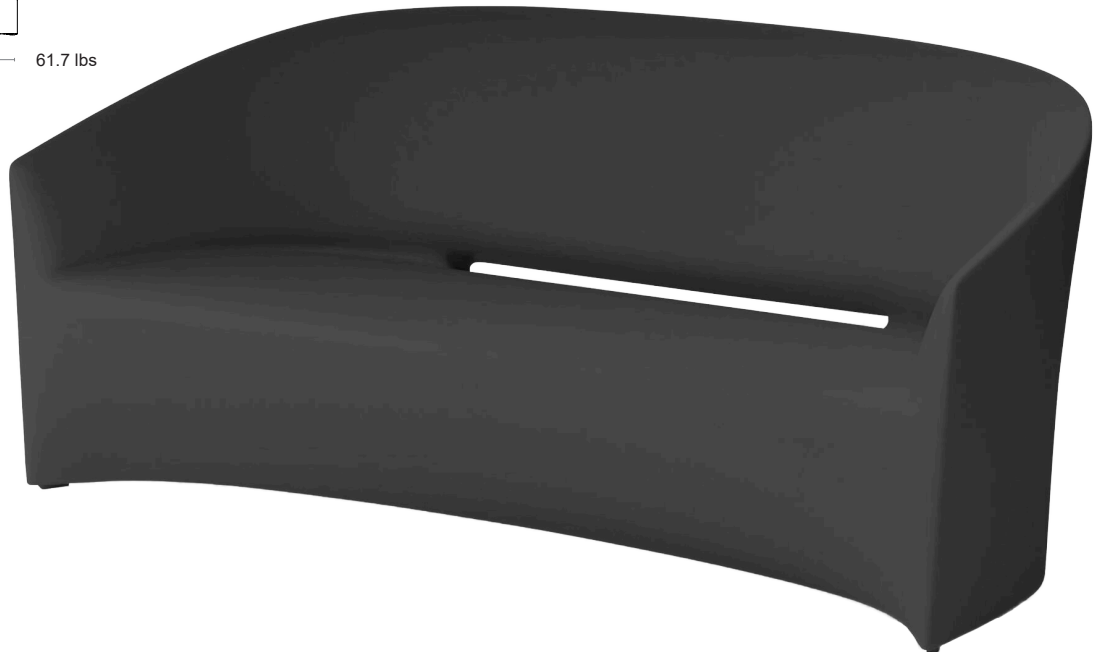
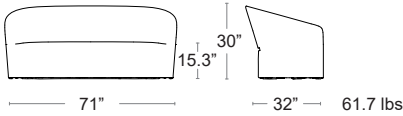

Pine Beach Club Chair

*L-SL-PINEBEA/AC-ANT

MSRP: \$1600 EA.

SELL: \$1040 EA.

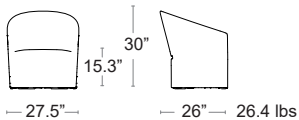

ANTRACITE

LOUNGE SEATING



Xena Club Chair

Aluminum frame with Synthetic rope back
Cushions included, Sunbrella Cast Pumice

MSRP: \$2180 EA. SELL: \$1420 EA.

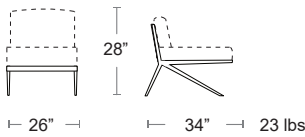

EMU-A1750-07-19-PUM



Darwin Collection

Tubular steel frame, Steel mesh seat and back
E-Plated Powder Coat finish



Darwin Loveseat

EMU-E527 + COLOUR CODE

MSRP: \$2340 EA. SELL: \$1520 EA.

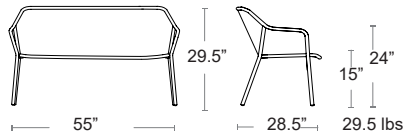

Darwin Lounge

EMU-E524 + COLOUR CODE

MSRP: \$1000 SELL: \$650 EA.

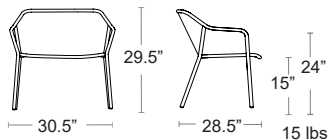

LOUNGE:
SEATING

**STYLE YOU CAN SIT ON,
QUALITY YOU CAN RELY ON**

LOUNGE SEATING



Lakeshore Loveseat

A classic design made from high density polyethylene (HDPE), Very high impact resistance with a textured finish, UV protected

MSRP: \$1350 EA. SELL: \$875 EA.

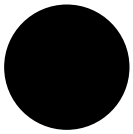
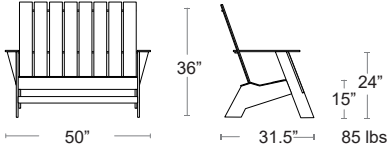

*L-BS-BSMAB-BLACK

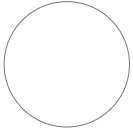

*L-BS-BSMAB-WHITE

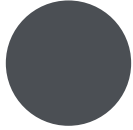

*L-BS-BSMAB-GREY



*L-BS-BSMAB-RED



SPECIAL ORDER



GOLDEN YELLOW



LIME GREEN



FOREST GREEN



COBALT

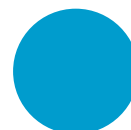

SKY BLUE



TAN LEATHER



CHOCOLATE

LOUNGE SEATING



Lakeshore Lounge

A classic design made from high density polyethylene (HDPE), Very high impact resistance with a textured finish, UV protected

MSRP: \$730 EA.

SELL: \$475 EA.

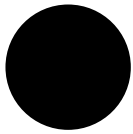
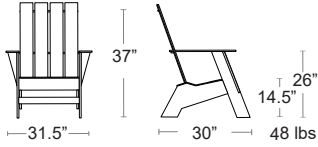

*L-BS-BSMAK-BLACK

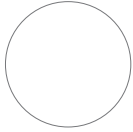

*L-BS-BSMAK-WHITE



*L-BS-BSMAK-GREY



*L-BS-BSMAK-RED



SPECIAL ORDER



GOLDEN YELLOW



LIME GREEN



FOREST GREEN

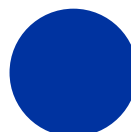

COBALT

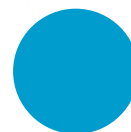

SKY BLUE



TAN LEATHER



CHOCOLATE

LOUNGE: SEATING

LOUNGE SEATING

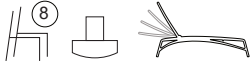

Folio

Reclining armchair. Uniformly coloured fiberglass polypropylene resins with UV additives. Matte finish, non-slip replaceable feet.

MSRP: \$470 EA. **SELL: \$355 EA.**

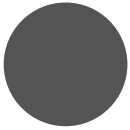
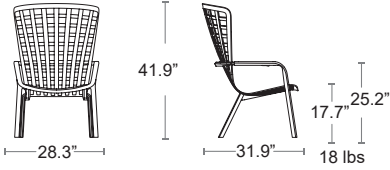

ANTRACITE
*L-NAR-
40300.02.04

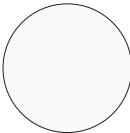

BIANCO
*L-NAR-
40300.00.04



TORTORA
*L-NAR-
40300.10.04



AGAVE
*L-NAR-
40300.16.04



SPECIAL ORDER



TABACCO
*L-NAR-
40300.53.04

LOUNGE SEATING



Folio Accessories Rocker Kit

Turn your Folio into a rocking chair with the rocker accessory

MSRP: \$110 EA. SELL: \$85 EA.

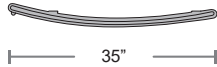

SPECIAL ORDER

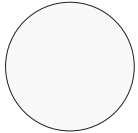

BIANCO
*L-NAR-40298.00

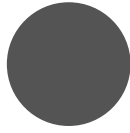

ANTRACITE
*L-NAR-40298.02



TORTORA
*L-NAR-40298.10



AGAVE
*L-NAR-40298.16



TABACCO
*L-NAR-40298.53



Cushion

Acrylic yarn dyed fabric with polyurethane foam and Velcro straps

**MSRP: \$410 EA.
SELL: \$265 EA.**



LINO
*C-NAR-36300.01.152

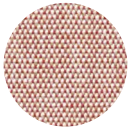

ROSA
SUNBRELLA
*C-NAR-36300.01.222

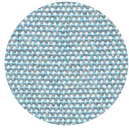

ARTIC
SUNBRELLA
*C-NAR-36300.01.223

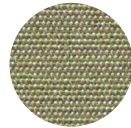

FELCE
SUNBRELLA
*C-NAR-36300.01.224

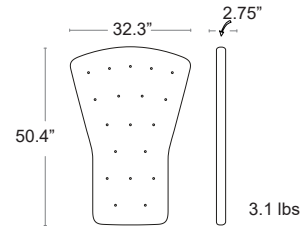

**MSRP: \$310 EA.
SELL: \$200 EA.**



GRIGIO
*C-NAR-36300.01.163

Headrest

Acrylic yarn dyed fabric with polyurethane foam and Velcro straps

**MSRP: \$100 EA.
SELL: \$65 EA.**

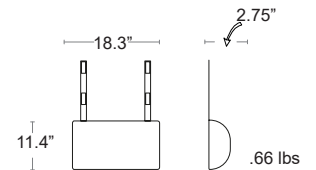

**MSRP: \$90 EA.
SELL: \$60 EA.**



LINO
*C-NAR-36300.04.152



ROSA SUNBRELLA
*C-NAR-36300.04.222



ARTIC SUNBRELLA
*C-NAR-36300.04.223



FELCE SUNBRELLA
*C-NAR-36300.04.224



GRIGIO
*C-NAR-36300.04.163

LOUNGE SEATING



Poggio Stool/Footrest

Uniformly coloured fiberglass polypropylene resins with UV additives, Matte finish

MSRP: \$160 EA. **SELL: \$120 EA.**

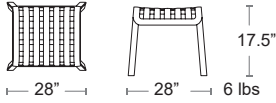

ANTRACITE
*L-NAR-40044.02

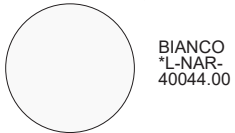

BIANCO
*L-NAR-40044.00



TORTORA
*L-NAR-40044.10

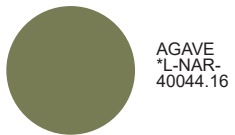

AGAVE
*L-NAR-40044.16



SPECIAL ORDER

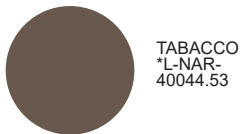

TABACCO
*L-NAR-40044.53



LOUNGE SEATING

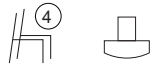

Net Bench

Uniformly coloured fiberglass and polypropylene with UV additives, Matte finish, Non-slip feet, Recyclable resin. See in stock cushions Page 157

MSRP: \$490 EA. SELL: \$365 EA.

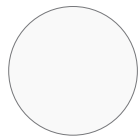
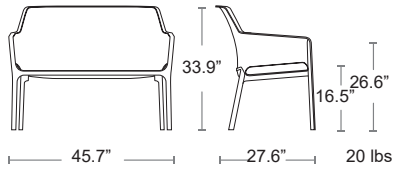

BIANCO
*L-NAR-40338.00



ANTRACITE
*L-NAR-40338.02



SALICE
*L-NAR-40338.04



TORTORA
*L-NAR-40338.10



SENAPE
*L-NAR-40338.56



CORALLO
*L-NAR-40338.75



LOUNGE SEATING

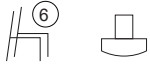

Net Relax

Uniformly coloured fiberglass and polypropylene with UV additives, Matte finish, Non-slip feet, Recyclable resin. See in stock cushions Page 157

MSRP: \$280 EA. SELL: \$210 EA.

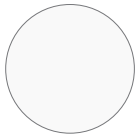
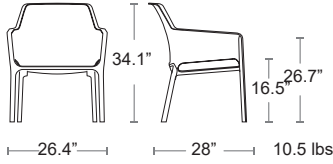

BIANCO
*L-NAR-40327.00

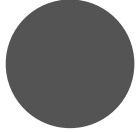

ANTRACITE
*L-NAR-40327.02



SALICE
*L-NAR-40327.04

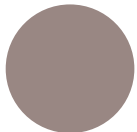

TORTORA
*L-NAR-40327.10



SENAPE
*L-NAR-40327.56



CORALLO
*L-NAR-40327.75



LOUNGE SEATING

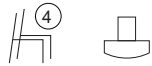

Net Lounge

Uniformly coloured fiberglass and polypropylene with UV additives, Matte finish, Non-slip feet, Recyclable resin.

MSRP: \$400 EA. SELL: \$300 EA.

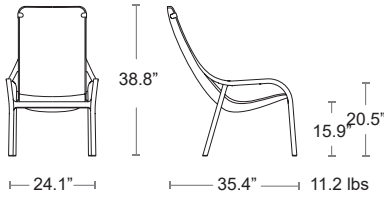

Headrest Cushion

With adjustable straps, Washable on delicate setting, 100% yarn dyed acrylic UV treated, dirt repellent & Mold resistant

MSRP: \$90 EA. SELL: \$60 EA.

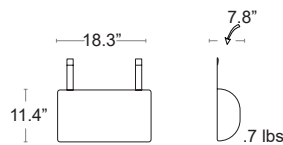

LOUNGE SEATING

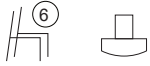

Doga Relax

Uniformly coloured fiberglass and polypropylene with UV additives, Matte finish, Non-slip feet, Recyclable resin, See in stock cushions Page 157

MSRP: \$330 EA. SELL: \$245 EA.

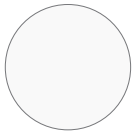
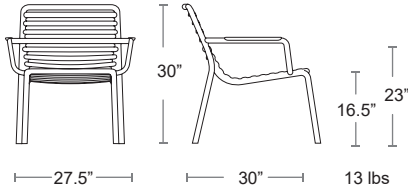

BIANCO
*L-NAR-40256.00

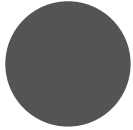

ANTRACITE
*L-NAR-40256.02



AGAVE
*L-NAR-40256.16



PERA
*L-NAR-40256.18



MARSALA
*L-NAR-40256.21



CAPPUCINO
*L-NAR-40256.14



MENTA
*L-NAR-40256.15



TABACCO
*L-NAR-40256.53



LOUNGE SEATING



Lounge Cushions

Made in North America, Sunbrella 100% Solution dyed acrylic, Zippered removable cover, washable, Custom Sunbrella Colours available for a 25% Surcharge

Net Bench

No ties

*C-BUM-NET-BENCH
+ COLOUR CODE

MSRP: \$250 EA.

SELL: \$165 EA.

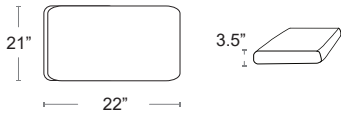

Doga Relax

Velcro ties

*C-BUM-DOGA-RELAX
+ COLOUR CODE

MSRP: \$210 EA.

SELL: \$140 EA.

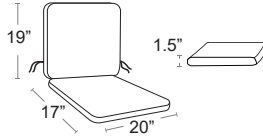

Net Relax

No ties

*C-BUM-NET-RELAX
+ COLOUR CODE

MSRP: \$120 EA.

SELL: \$80 EA.

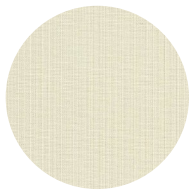
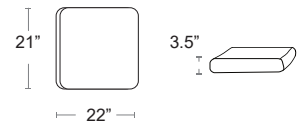

SPECTRUM EGGSHELL
-48018

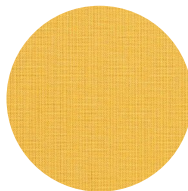

SPECTRUM DAFFODIL
-48024

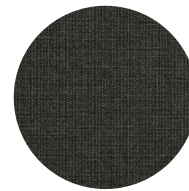

SPECTRUM CARBON
-48085

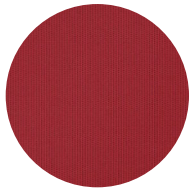

SPECTRUM CHERRY
-48096



CANVAS GRANITE
-5402

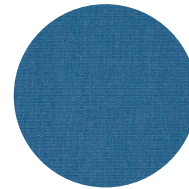

CANVAS REGATTA
-5493

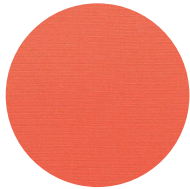

CANVAS MELON
-5415

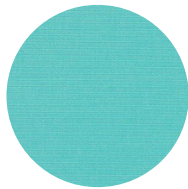

CANVAS ARUBA
-5416

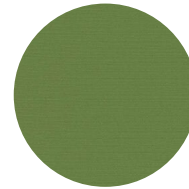

CANVAS PALM
-5421

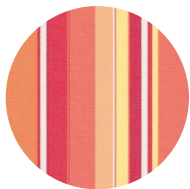

DOLCE MANGO
-56000



DOLCE OASIS
-56001



PEYTON GRANITE
-56075



MILANO CHAR
-56079



CABANA REGATTA
-58029



CABANA CLASSIC
-58030



Custom Cushions & Special Orders

We can make cushions for all the chairs and stools we sell in available Sunbrella Fabric
We have swatches and samples of Special Order colours and fabrics.
Contact BUM for samples and pricing samplerrequest@bumoutdoor.ca

LOUNGE SEATING LOUNGE CUSHIONS



Throw Pillows

Sunbrella 100% Solution Dyed acrylic, Washable zippered removable cover
 Complements the Net and Deep Seating lounge collections
 Custom Sunbrella cushions available for a 25% surcharge, expect 3 weeks for delivery

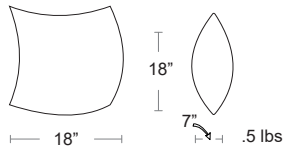

Toss
MSRP: \$80 EA.
SELL: \$40 EA.

*C-BUM-TOSS + COLOUR CODE

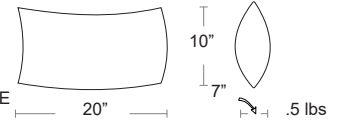

Bolster
MSRP: \$80 EA.
SELL: \$40 EA.

*C-BUM-BOLSTER + COLOUR CODE



SPECTRUM EGGSHELL
-48018



SPECTRUM DAFFODIL
-48024



SPECTRUM CARBON
-48085



SPECTRUM CHERRY
-48096



CANVAS GRANITE
-5402



CANVAS MELON
-5415



CANVAS ARUBA
-5416



CANVAS PALM
-5421



DOLCE MANGO
-56000



CANVAS REGATTA
-5493



PEYTON GRANITE
-56075



MILANO CHAR
-56079



CABANA REGATTA
-58029



CABANA CLASSIC
-58030



DOLCE OASIS
-56001



Custom Cushions & Special Orders

We can make cushions for all the chairs and stools we sell in available Sunbrella Fabric
 We have swatches and samples of Special Order colours and fabrics.
 Contact BUM for samples and pricing samplerrequest@bumoutdoor.ca

LOUNGE SUN BEDS

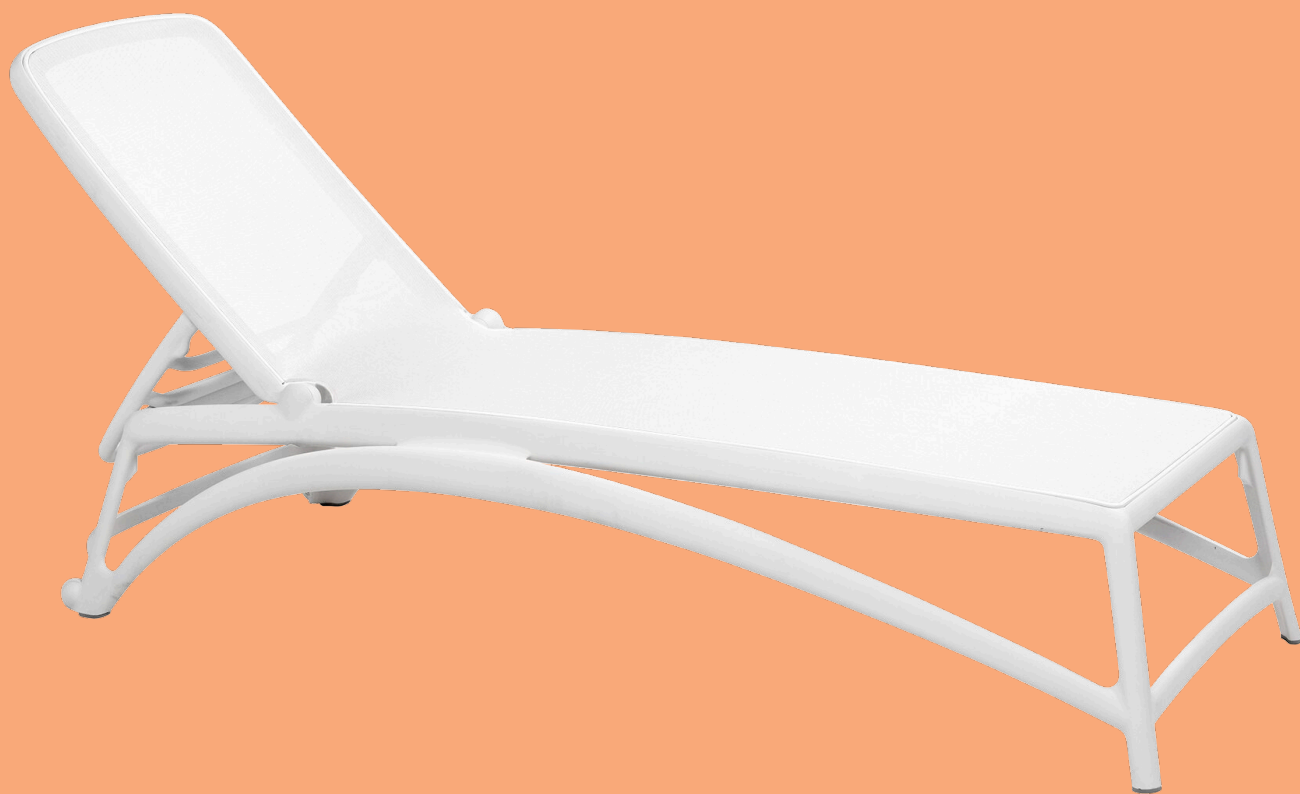

LOUNGE SUN BEDS



Skyline Chaise Lounger

All weather polyethylene wicker double fish bone weave, pattern for extra strength and durability, hand woven. Fully welded aluminum frame, E-Plated Powder Coat finish Includes Sunbrella cushions, zippered for easy cleaning

MSRP: \$1200 EA. SELL: \$600 EA.

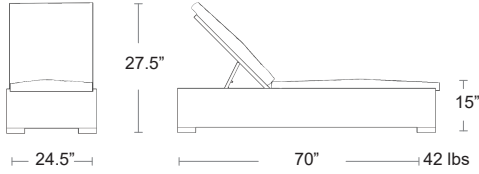

*@-L-BUM-SKY-515

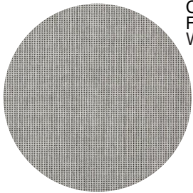

CUSHIONS - SUNBRELLA VOLT SILVER
FRAME - POLYETHYLENE ALL WEATHER WICKER



City View Chaise Lounger

E-Plated Powder Coat finish, welded Aluminum frame, sling seat and back for added comfort Includes Sunbelievable cushions, zippered for easy cleaning

MSRP: \$1200 EA. SELL: \$600 EA.

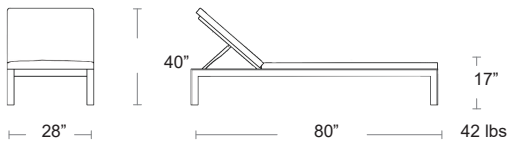

*@-L-BUM-CITYVIEW-515

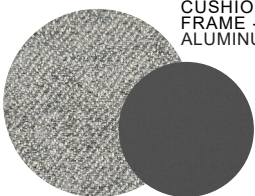

CUSHIONS - VENUS DOLPHIN
FRAME - ANTRACITE WELDED ALUMINUM

LOUNGE SUN BEDS



Aqua Lounger

In water chaise, All-weather resistant, UV protection, 100% recyclable LLDPE (linear low-density polyethylene), solution dyed, Suitable for poolside or in water up to 15 cm/5.9" High degree of mechanical strength and resistance to impacts

MSRP: \$1200 EA. SELL: \$720 EA.

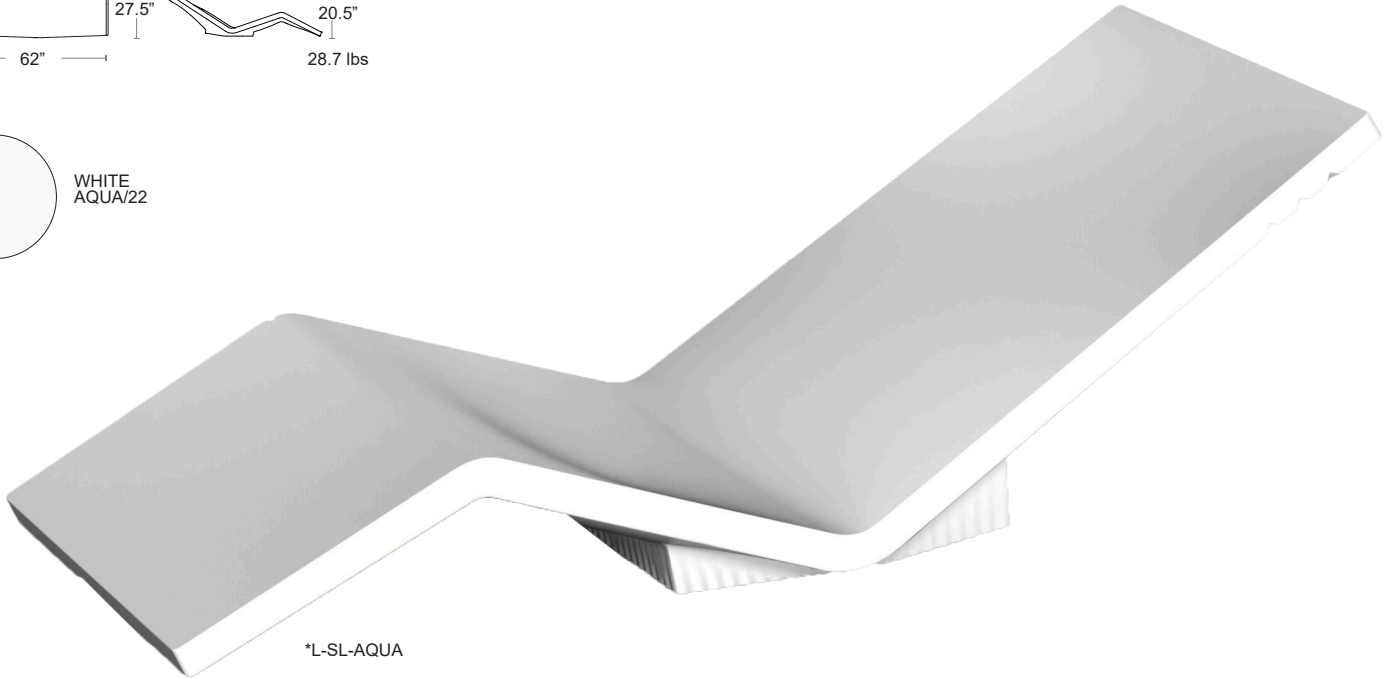
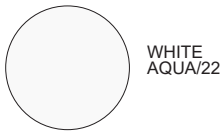
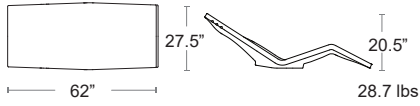

Fill with water using the hole in the backrest. This stabilizes the lounger in the water so it won't float.



LOUNGE SUN BEDS

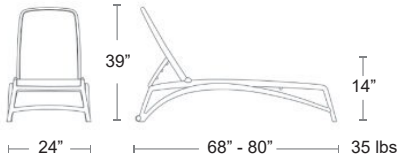
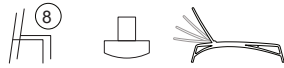

Atlantico

Uniformly coloured fiberglass and polypropylene with UV additives, breathable synthetic fabric sling, 4 position reclining, hidden wheels, Matte finish, Non-slip feet, Recyclable resin.

MSRP: \$710 EA. SELL: \$530 EA.



ANTRACITE/ANTRACITE
*L-NAR-40450.02.057



TORTORA/TORTORA
*L-NAR-40450.10.104

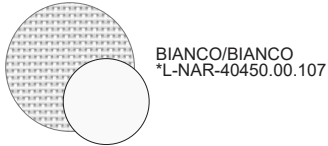

BIANCO/BIANCO
*L-NAR-40450.00.107

Atlantico Arms

MSRP: \$50 EA. SELL: \$35 EA.

2 arms included, Chair sold separately

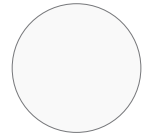

BIANCO
*L-NAR-40452.00

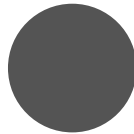

ANTRACITE
*L-NAR-40452.02

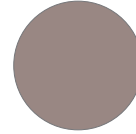

TORTORA
*L-NAR-40452.10



Replacement Fabric - Atlantico

MSRP: \$190 EA. SELL: \$125 EA.



ANTRACITE
*PT-NAR-40460.01.057



TORTORA
*L-Nar-40460.10.104



BIANCO
*PT-NAR-40460.00.107



SPECIAL ORDER

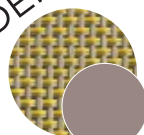

TORTORA/
DESERTO
40450.10.103

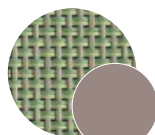

TORTORA/
AGAVE
40450.10.101

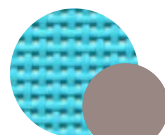

TORTORA/
CELESTE
40450.10.075

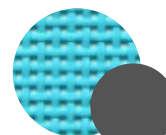

ANTRACITE/
CELESTE
40450.02.075



BIANCO/
TORTORA
40450.00.104

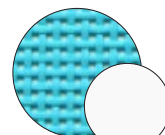

BIANCO/
CELESTE
40450.00.075

LOUNGE SUN BEDS



PAPATYA

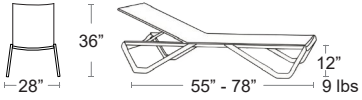

Wave Sun Lounger

Stackable polypropylene and aluminum frame with water resistant seat material

MSRP: \$630 EA. **SELL: \$410 EA.**

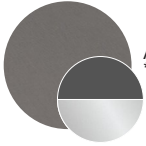

ANTRACITE
*L-PPY-WAVE-22-05700

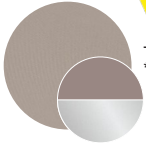

TAUPE
*L-PPY-WAVE-61-50070

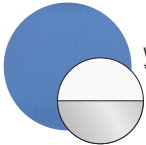

WHITE/BLUE
*L-PPY-WAVE-01-05009

LOUNGE SUN BEDS

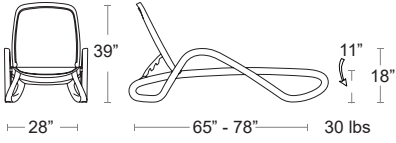
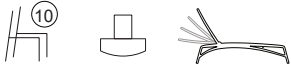

Alfa

Uniformly coloured fiberglass and polypropylene with UV additives, breathable synthetic fabric sling, 4 position reclining, hidden wheels, Matte finish, Non-slip feet, Recyclable resin.

MSRP: \$560 EA. SELL: \$365 EA.

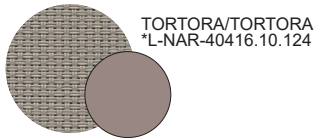
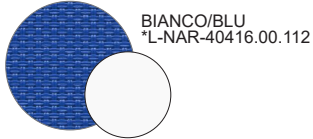

Alfa Parasol

MSRP: \$100 EA. SELL: \$65 EA.



Replacement
Fabric - Alfa
MSRP: \$180 EA.
SELL: \$120 EA.

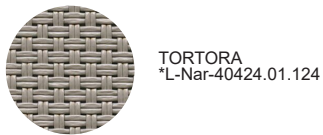
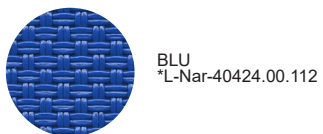

LOUNGE SUN BEDS

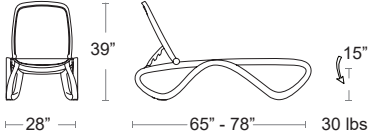
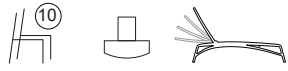

Omega

Uniformly coloured fiberglass and polypropylene with UV additives, breathable synthetic fabric sling, 4 position reclining, hidden wheels, Matte finish, Non-slip feet, Recyclable resin.

MSRP: \$560 EA. SELL: \$365 EA.

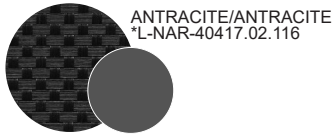

Omega Parasol

MSRP: \$100 EA. SELL: \$65 EA.



Replacement Fabric - Omega

MSRP: \$180 EA. SELL: \$120 EA.

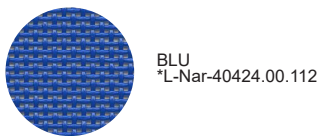

LOUNGE TABLES

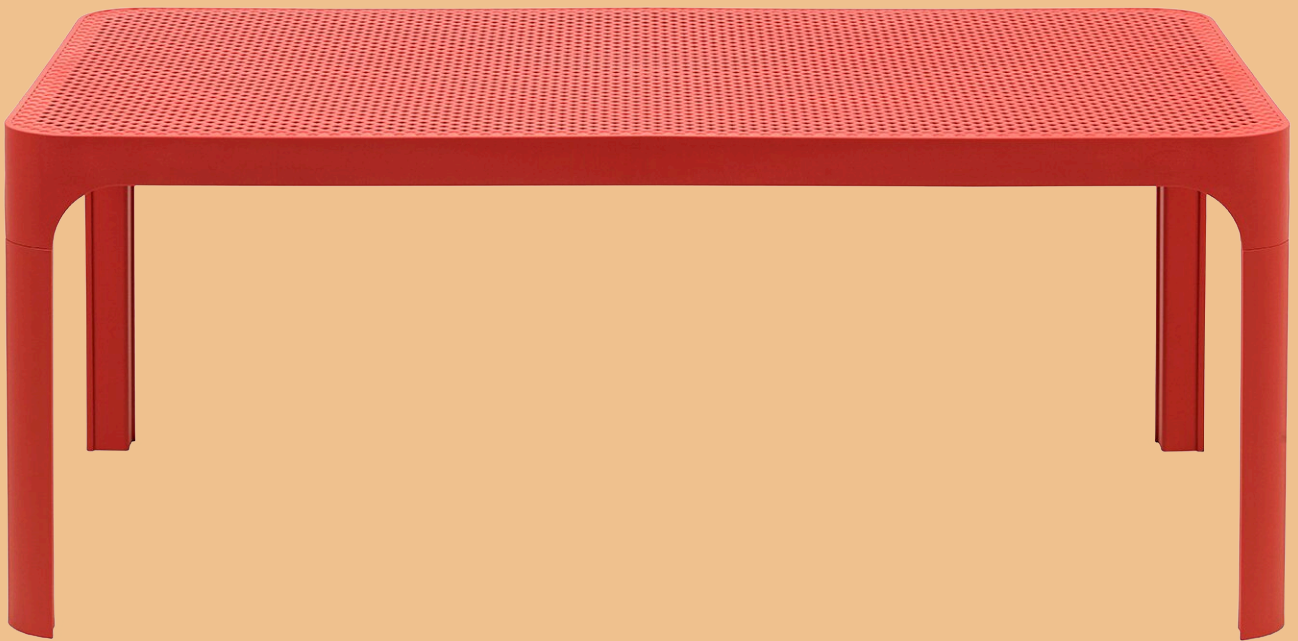



Darwin

Tubular steel frame, Steel top
E-Plated Powder Coat finish

MSRP: \$1150 EA. SELL: \$750 EA.

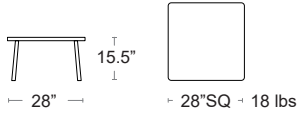

WHITE
EMU-E526-23



BLACK
EMU-E526-24



BRONZE
EMU-E526-41



LOUNGE:
TABLES

LOUNGE TABLES



Jakarta Teak Collection

Solid Teak construction, Teak will develop a warm gray patina over time or it can be oiled annually to maintain the look of new wood.

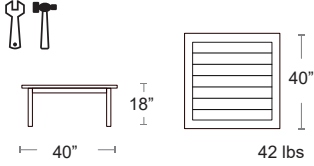

Coffee Table

*L-BUM-TEAK.COFFEE

MSRP: \$1140 EA.

SELL: \$740 EA.

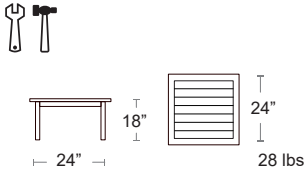

Side Table

*L-BUM-TEAK.SIDE

MSRP: \$770 EA.

SELL: \$500 EA.

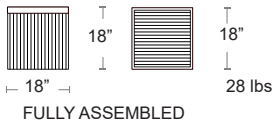

Cube Side Table/Stool

*L-BUM-TEAK.CUBE

MSRP: \$740 EA.

SELL: \$480 EA.



TEAK

LOUNGE TABLES

LOUNGE TABLES

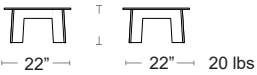
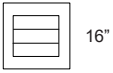
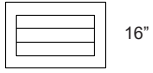

BLACK



WHITE



GREY



RED

Amalfi/Lakeshore Collection

A classic design made from high density polyethylene (HDPE), Very high impact resistance with a textured finish, UV protected

Coffee Table

*L-BS-BSMRC + COLOUR

MSRP: \$820 EA.

SELL: \$535 EA.



Side Table

*L-BS-BSMOS + COLOUR

MSRP: \$620 EA.

SELL: \$405 EA.



SPECIAL ORDER



GOLDEN YELLOW



LIME GREEN



FOREST GREEN

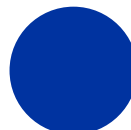

COBALT

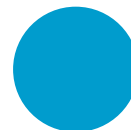

SKY BLUE



TAN LEATHER



CHOCOLATE

LOUNGE TABLES



Urban Collection

Welded Aluminum frame, E-Plated Powder Coat finish

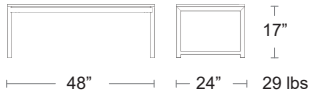

Coffee Table

*@L-BUM-URBAN-2448

MSRP: \$900 EA.

SELL: \$450 EA.

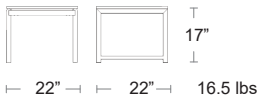

Side Table

*@L-BUM-URBAN-22SQ

MSRP: \$570 EA.

SELL: \$285 EA.



City View Collection

Welded Aluminum frame, E-Plated Powder Coat finish

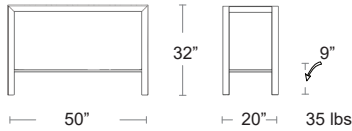

Console Table

*L-BUM-CITYVIEW-2050T

MSRP: \$760 EA.

SELL: \$495 EA.

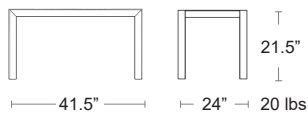

Coffee Table

*L-BUM-CITYVIEW-2442

MSRP: \$630 EA.

SELL: \$410 EA.

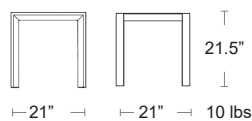

Side Table

*L-BUM-CITYVIEW-20SQ

MSRP: \$360 EA.

SELL: \$235 EA.



LOUNGE TABLES

LOUNGE TABLES



Skyline Tables

All weather wicker fish bone weave, Welded aluminum frame, E-Plated Powder Coat finish, Frosted glass top

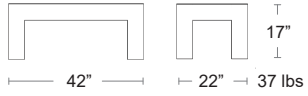

Coffee Table

*@-L-BUM-SKY-4222C

MSRP: \$640 EA.

SELL: \$420 EA.

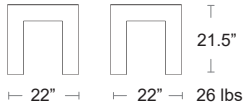

Side Table

*@-L-BUM-SKY-22SQ

MSRP: \$570 EA.

SELL: \$370 EA.

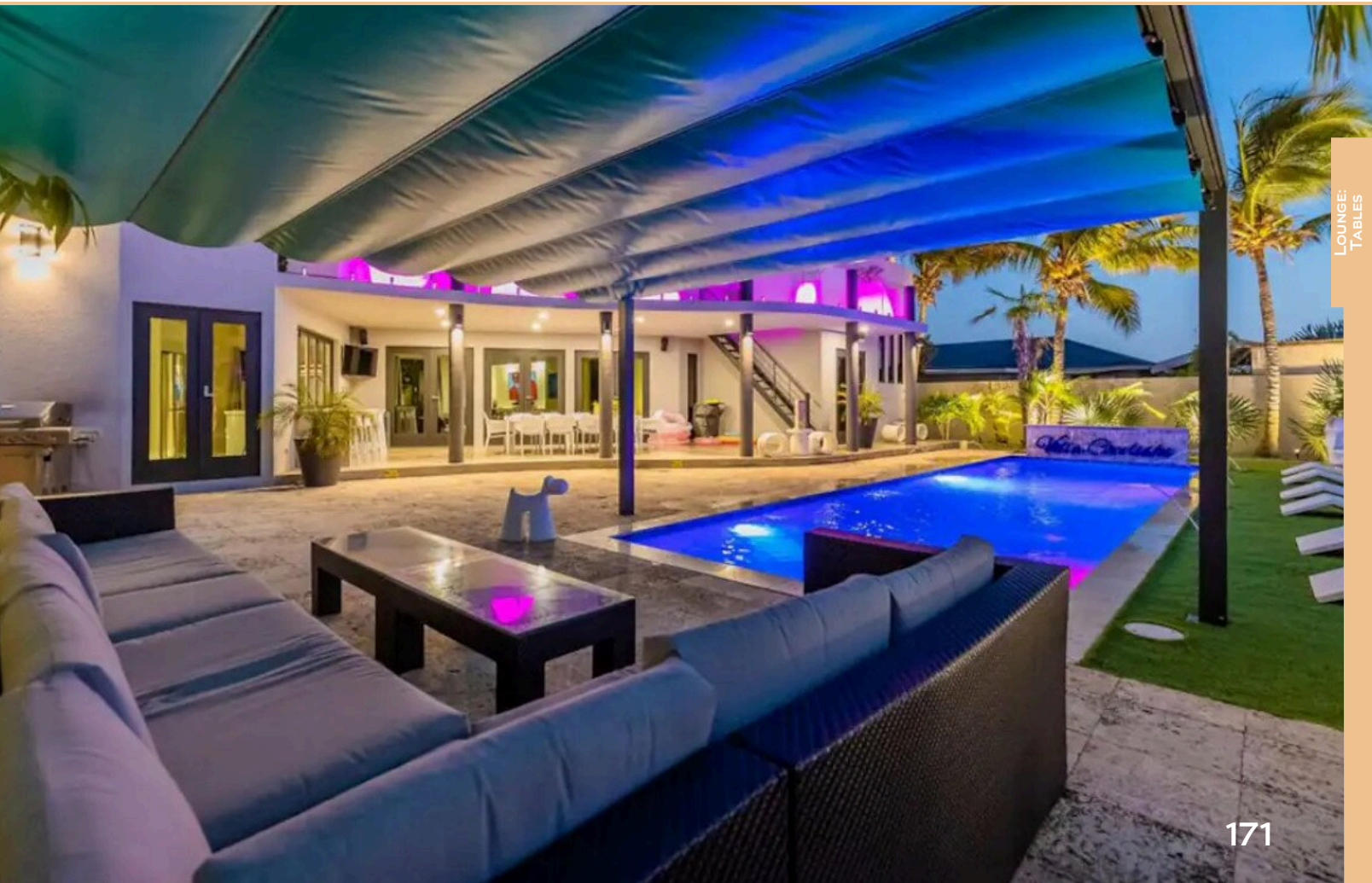

LOUNGE TABLES



SERRALUNGA

Juju Stool/Side Table

UV Protected, LLDPE (linear low density polyethylene),
100% Recyclable, Solution Dyed, Impact resistant,
Stable, light and easy to handle

MSRP: \$560 EA. SELL: \$365 EA.

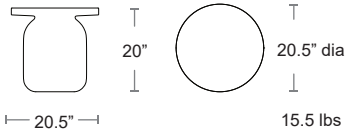

ANTRACITE
*L-SL-JUJU-ANT

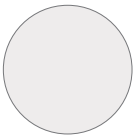

WHITE
*L-SL-JUJU-IWH



LIGHT GREY
*L-SL-JUJU-GG



LIGHT YELLOW
*L-SL-JUJU-GS



RED
*L-SL-JUJU-RO



TORTORA
*L-SL-JUJU-TO



OLIVE GREEN
*L-SL-JUJU-VOC



LOUNGE:
TABLES

LOUNGE TABLES



Cero Side Table

Sculptural informal seat/foot rest and decorative element, UV Protected, LLDPE (linear low density polyethylene 100% Recyclable, Solution Dyed Impact resistant

MSRP: \$480 EA. SELL: \$315 EA.

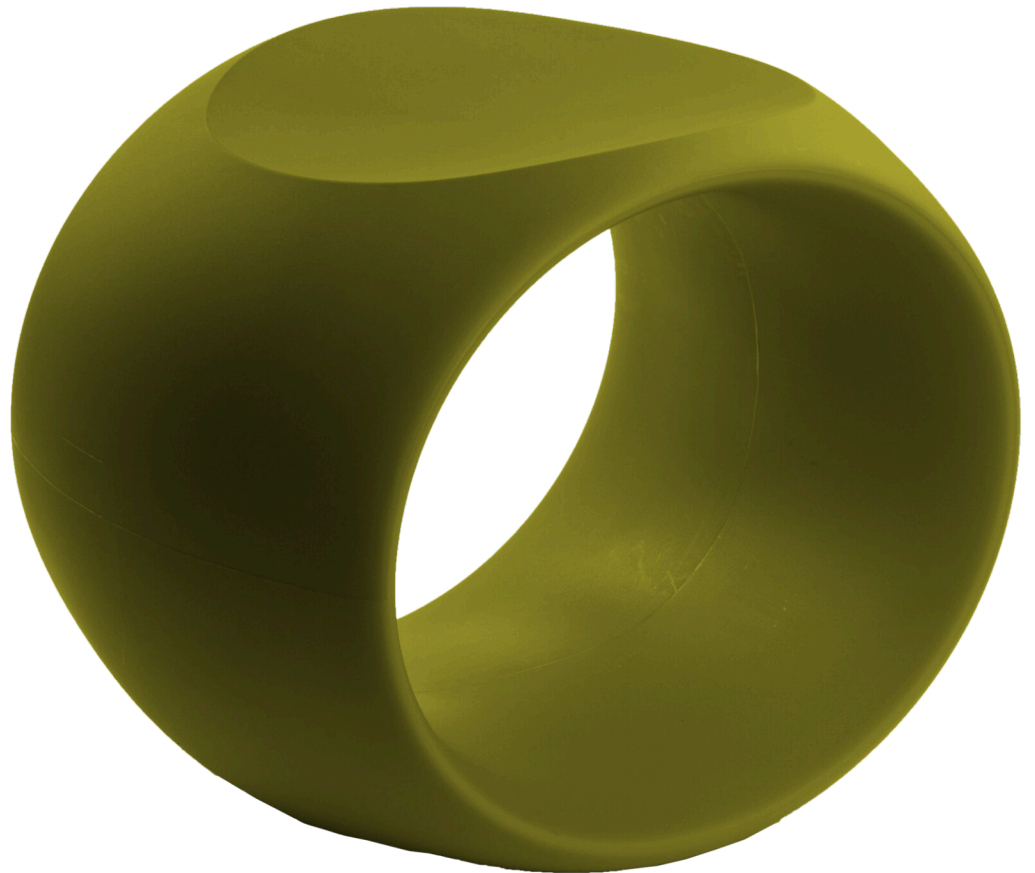
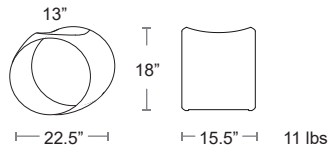

LOUNGE TABLES

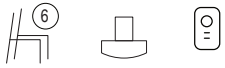

Disco Side Table

Steel tubular frame and steel mesh top
E-Plated Powder Coat finish

MSRP: \$350 EA. SELL: \$230 EA.

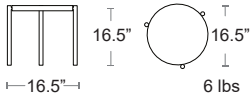

IRON
EMU-E100-22



WHITE
EMU-E100-23



BRONZE
EMU-E100-41



GREEN
EMU-E100-60



LOUNGE TABLES

LOUNGE TABLES



NARDI
YOUR OUTDOOR LIVING

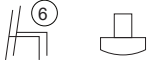

Net 100

Uniformly coloured fiberglass polypropylene with UV additives
Perforated top, Matte finish, Non-slip feet, Recyclable

MSRP: \$240 EA. SELL: \$180 EA.

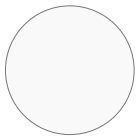
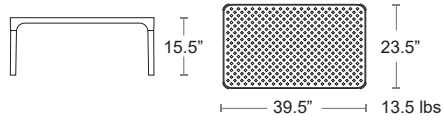

BIANCO
*L-NAR-40064.00

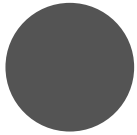

ANTRACITE
*L-NAR-40064.02



SALICE
*L-NAR-40064.04



TORTORA
*L-NAR-40064.10



SENAPE
*L-NAR-40064.56



CORALLO
*L-NAR-40064.75

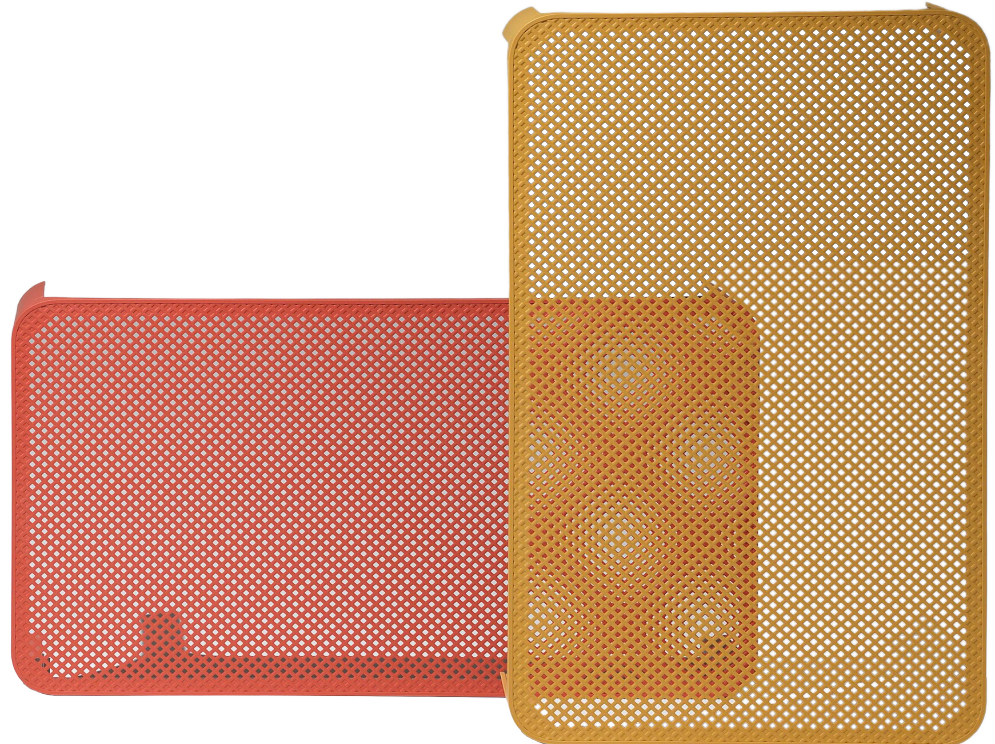

LOUNGE TABLES



Doga Side Table

Uniformly coloured fiberglass and polypropylene with UV additives, Matte finish, Non-slip feet, Recyclable resin.

MSRP: \$150 EA. SELL: \$110 EA.

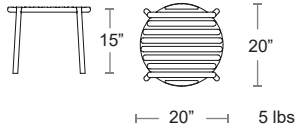

LOUNGE: TABLES

LOUNGE TABLES

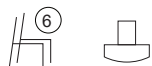

Pop

Resin and fiberglass, UV protected, Removeable shelf included

MSRP: \$130 EA. SELL: \$95 EA.

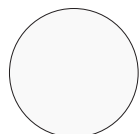
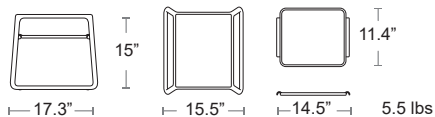

BIANCO
*L-NAR-40048.00

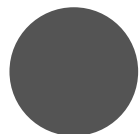

ANTRACITE
*L-NAR-40048.02



TORTORA
*L-NAR-40048.10



LOUNGE TABLES



NARDI
YOUR OUTDOOR LIVING

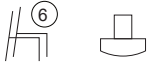

Rodi

Resin Table, UV protected

MSRP: \$80 EA. SELL: \$50 EA.

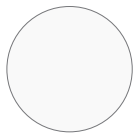
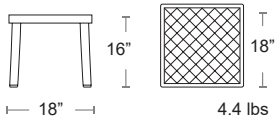

BIANCO
*L-NAR-40050.00



ANTRACITE
*L-NAR-40050.02



TORTORA
*L-NAR-40050.10



GRIGIO
*L-NAR-40050.03



CAFFE
*L-NAR-40050.05



LOUNGE:
TABLES

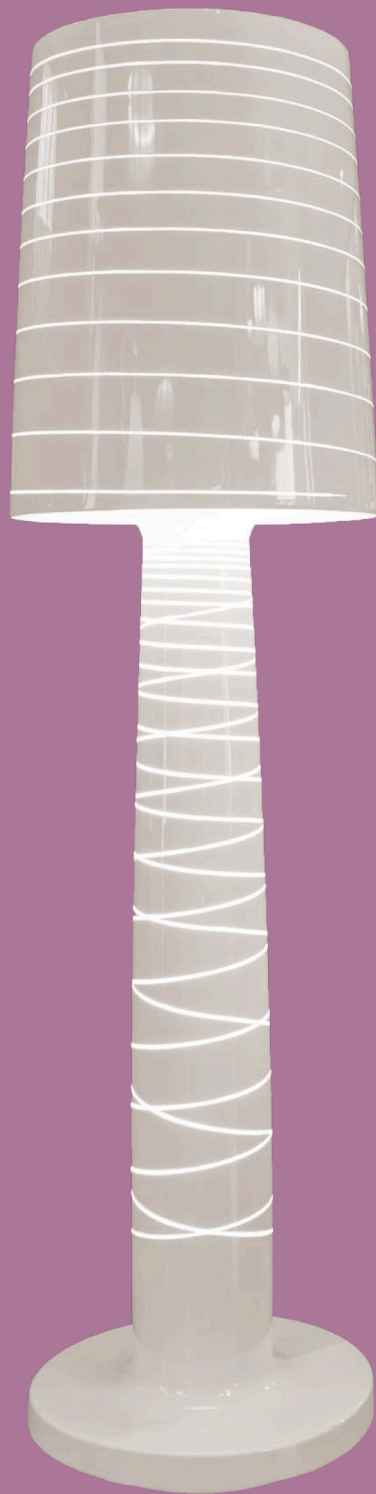

COMPLEMENTS



Air Lounge Hammock

Durable Stainless Steel frame, expandable ultra comfort sun mesh fabric with UV stabilized sun dye and durable hardwood stretcher bars, Easy to assemble, Storage/ carry bag included

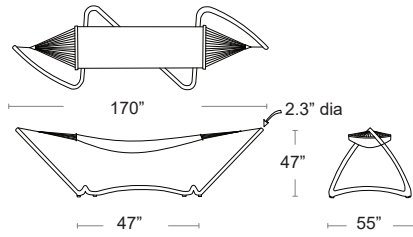

MSRP: \$6520 EA. SELL: \$3900

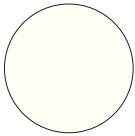

NATURAL
*CP-TU-AIRLOUNGE2-
NAT + *CP-TU-WSS



BLACK
*CP-TU-AIRLOUNGE2-
BK + *CP-TU-WSS



COMPLEMENTS



SERRALUNGA



Floor Lamps

Lacquered surface specially engraved to create an astonishing effect of light and shade that is one of a kind. The Lady Jane and Lady Mary floor lamps are over 2 metres high and are awe-inspiring, theatrical objects.

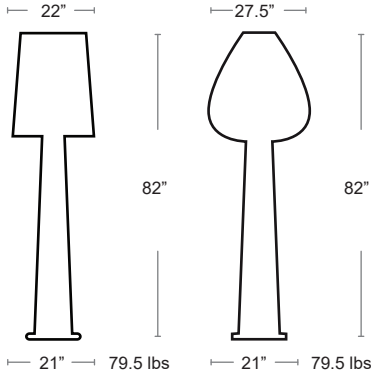

Lady Jane

*CP-SL-LADYJ/LE/D + COLOUR CODE

MSRP: \$6620 EA.

SELL: \$3970 EA.

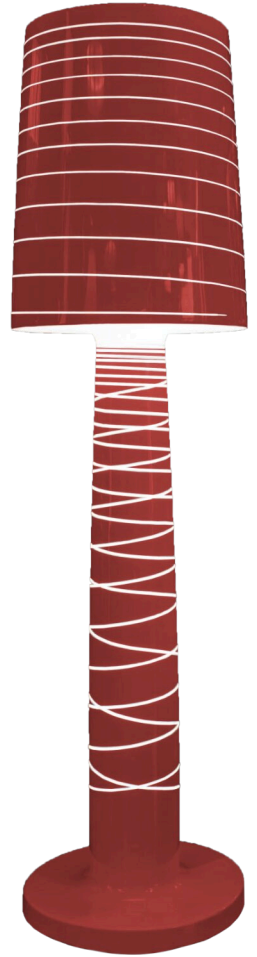

BLACK
-LBK

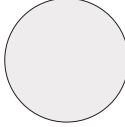

WHITE
-LWH

Lady Mary

*CP-SL-LADYM/LE/D + COLOUR CODE

MSRP: \$6620 EA.

SELL: \$3970 EA.



ANTRACITE
-LAN



RED
-LRO



Miss Jane Floor Lamp

A scaled down version of the Lady Jane

*CP-SL-MISSJ/LE/D + COLOUR CODE

MSRP: \$4400 EA.

SELL: \$2640 EA.

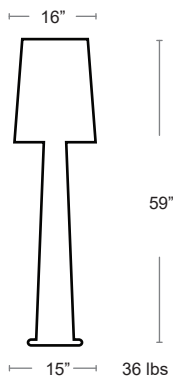

COMPLEMENTS

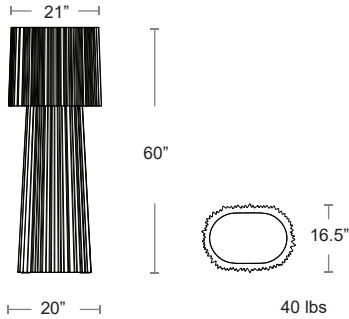

Ruffle

LLDPE (linear low-density polyethylene) achieved by rotational molding. UV protection. 100% recyclable, solution dyed. High degree of mechanical strength and resistance to impacts.

Wireless RGB LED System - 1.2W

RGB led - 3.7V,

2200 mAh lithium-ion battery - class III.

Charging station for indoor use: input 110/240V - 50/60

Remote Control Included

MSRP: \$3020 EA. SELL: \$1800 EA.

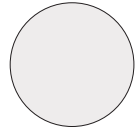

WHITE



*CP-SL-RUFFLE-P/LD

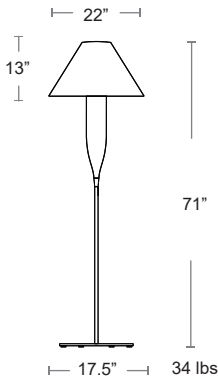

Bonheur

White matte polymer spreads the light softly, creating a contrast with the deep grey of the base.

impact-proof polyethylene wide base for increased stability.

MSRP: \$2400 EA. SELL: \$1440 EA.



*CP-SL-BONHEUR-P

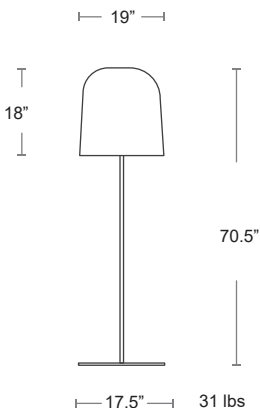

Odette

Lampshade (linear polyethylene) achieved by rotational molding. UV protection. 100% recyclable, solution dyed.

High degree of mechanical strength and resistance to impacts. Steel frame lacquered for outdoor usage.

MSRP: \$2200 EA. SELL: \$1320 EA.



*CP-SL-ODETTE/LR

COMPLEMENTS



Bartolomeo Modular Bar Collection

Modular elements, easy to move, impact-resistant polyethylene construction

Use alone or paired with other components to create what you need

Bartolomeo Bar Neutral

WITH 2 WHITE LIGHTS, 1 SHELF & WHEELS

MSRP: \$4880 EA. SELL: \$2930 EA.

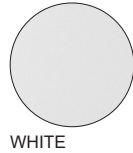
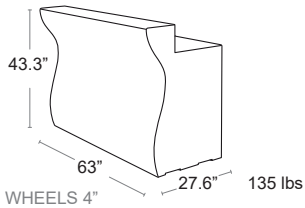
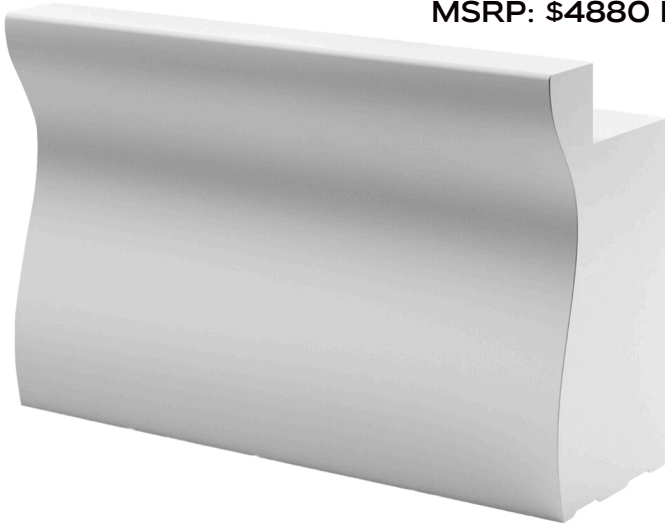
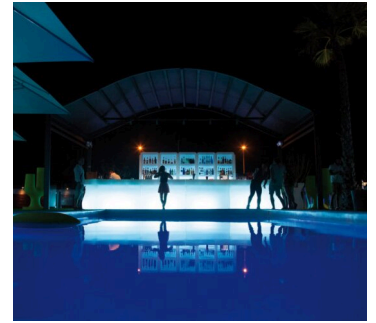

WHITE

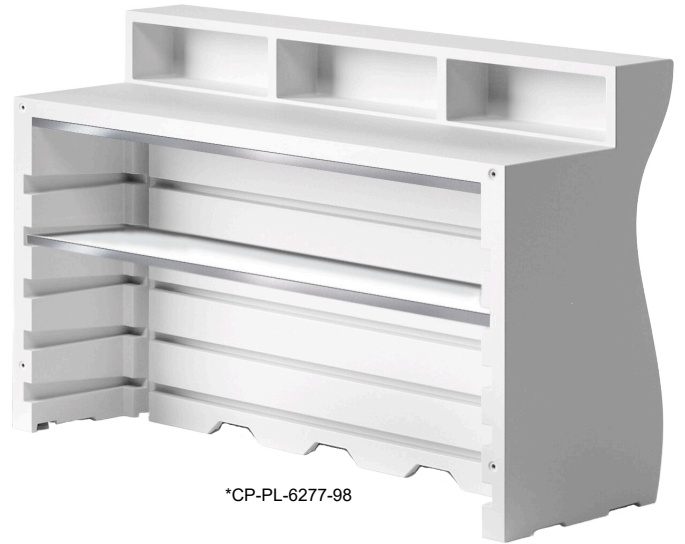

*CP-PL-6277-98

Bartolomeo Bar Black

WITH 1 SHELF & WHEELS

MSRP: \$4450 EA. SELL: \$2670 EA.

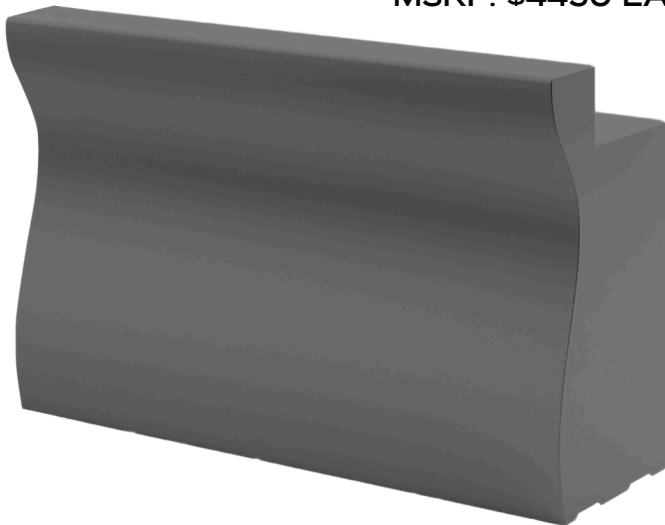

BLACK

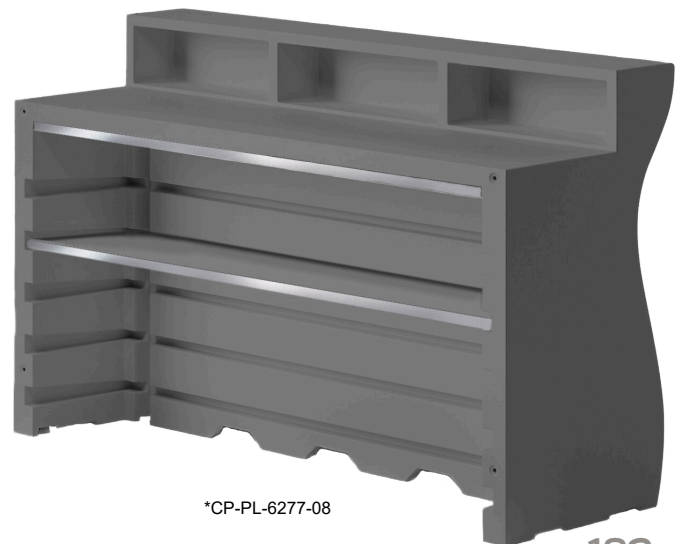

*CP-PL-6277-08

COMPLEMENTS



Bartolomeo Corner Neutral WITH 1 WHITE LIGHT & WHEELS

MSRP: \$2250 EA. SELL: \$1350 EA.



*CP-PL-6278-98

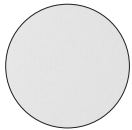

WHITE

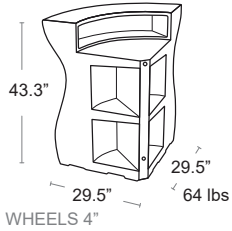

Double Corner



Bar & Corner

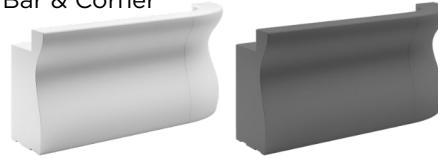

Bartolomeo Corner Black WITH WHEELS

WITH WHEELS

MSRP: \$2040 EA. SELL: \$1225 EA.

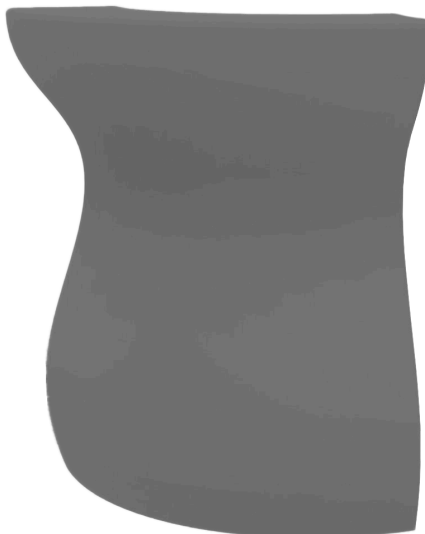

*CP-PL-6278-08



BLACK



Frozen Catering Counter

Catering counter and ice container with removable countertop. Impact resistant polyethylene construction, two compartments, lid fits either side, easy to move

Frozen Catering Counter Neutral

2 WHITE LIGHTS, HALF TOP & WHEELS

MSRP: \$3640 EA. **SELL: \$2185 EA.**

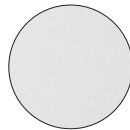

WHITE
*CP-PL-6413-98

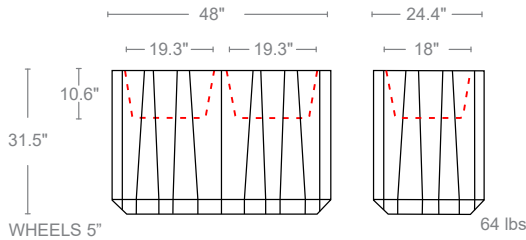

Frozen Catering Counter Black

WITH HALF TOP AND WHEELS

MSRP: \$3210 EA. **SELL: \$1925 EA.**



BLACK
*CP-PL-6413-08

COMPLEMENTS



Bartolomeo
Bar Display Neutral
WITH 1 WHITE LIGHT
MSRP: \$2620 EA.
SELL: \$1570 EA.

Bartolomeo
Bar Display Black
MSRP: \$2310 EA.
SELL: \$1385 EA.

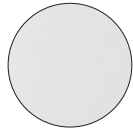
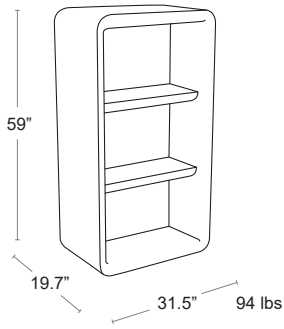

WHITE
*CP-PL-6278-98



BLACK
*CP-PL-6278-08

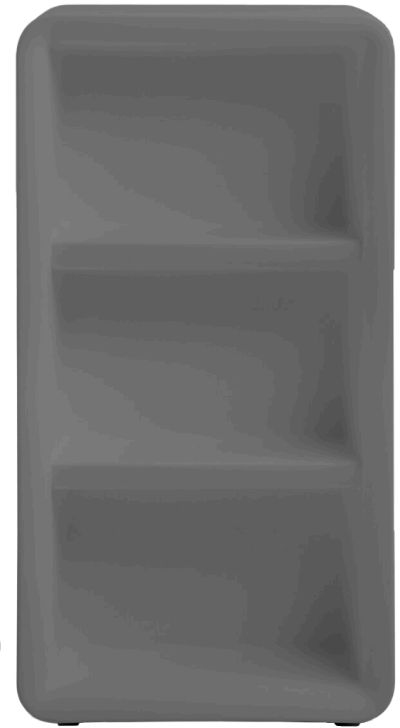



Jakarta Teak Collection

Solid Teak construction, Teak will develop a warm gray patina over time or it can be oiled annually to maintain the look of new wood, Teak requires virtually no maintenance and can be left on the patio during the summer months.

Bench

*CP-BUM-TEAK-BENCHwBACK-6'

MSRP: \$1820 EA. SELL: \$1200 EA.

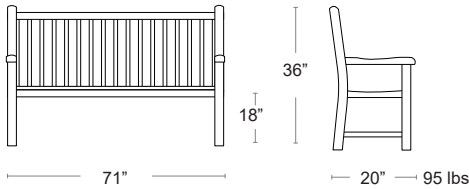

Backless Bench

*CP-BUM-TEAK-BENCH-6'

MSRP: \$1200 EA. SELL: \$780 EA.

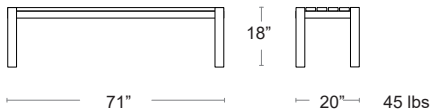

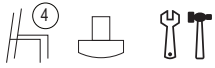

Segno Benches

Square tubular steel frame, Steel slat seat and back
E-Plated E-Plated Powder Coat finish, Can be bolted down
bolt down sold separately

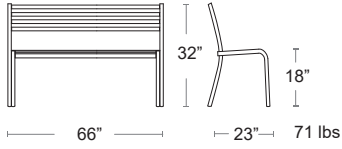

Segno E159

EMU-E159 + COLOUR CODE

MSRP: \$1800 EA.

SELL: \$1080 EA.

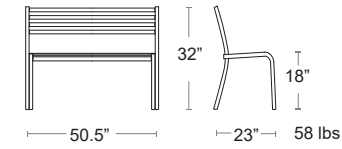

Segno E158

E158 + COLOUR CODE

MSRP: \$1600 EA.

SELL: \$960 EA.

Bolt Down Kit

MSRP: \$100 EA.

SELL: \$60 EA.



IRON
-22



BLACK
-24



BRONZE
-41



COMPLEMENTS



Pulcino

Resin sculptural element
UV Protected, -40C +40C

MSRP: \$420 EA. SELL: \$250 EA.

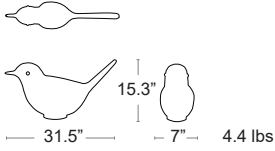

TORTORA
*CP-SL-PULCINO-TO

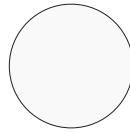

WHITE
*CP-SL-PULCINO-WH



Otto

Resin sculptural element
UV Protected, -40C +40C

MSRP: \$360 EA. SELL: \$220 EA.

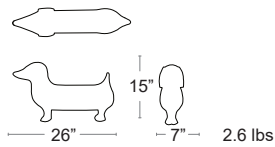

ANTRACITE
*CP-SL-OTTO-ANT



TORTORA
*CP-SL-OTTO-TO

COMPLEMENTS



SERRALUNGA

Doggy

Resin sculptural element
UV Protected, -40C +40C

MSRP: \$360 EA. SELL: \$220 EA.

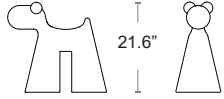

23.6" 21.6" 10.8" 4.9 lbs



ANTRACITE
*CP-SL-55-ANT



DALMATION
*CP-SL-55-DAL

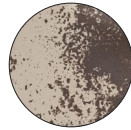

DELAVE/
COFFEE
*CP-SL-55-ICA

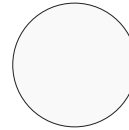

WHITE
*CP-SL-55-WH



SERRALUNGA

Gatt One

Resin sculptural element
UV Protected, -40C +40C

MSRP: \$290 EA.

SELL: \$175 EA.



13.4" 19.7" 5.5" 2.2 lbs



BLACK
*CP-SL-GATTONE-BK

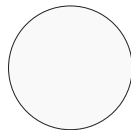

WHITE
*CP-SL-GATTONE-WHT

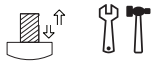

Corner Post

*CP-SSP-P223A-PLUS2-001



End Post

*CP-SSP-P223E-PLUS2-001



Straight Post

*CP-SSP-P223S-PLUS2-001



3' Panel

*CP-SSP-PP3000-001

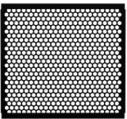

5' Panel

*CP-SSP-PP5000-001

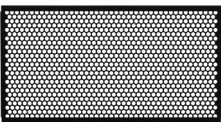

7' Panel

*CP-SSP-PP7000-001

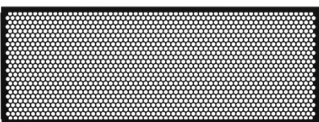

Gate Set

*CP-SSP-GS001-PLUS2-001

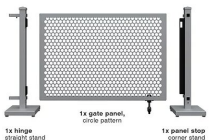

BLACK
RAL9017

Bum Fence

The panels and stands connect quickly and easily with spring push-buttons. Temporary or permanent, bases come with bolt hole knock-outs that can be removed and used to bolt the partitions into the ground.

Panels are fabricated from heavy gauge perforated aluminum. Posts are heavy gauge aluminum and stainless steel bases, with leveling legs for uneven ground. All components are E-Plated Powder Coat and rust proofed.

CALL FOR PRICING

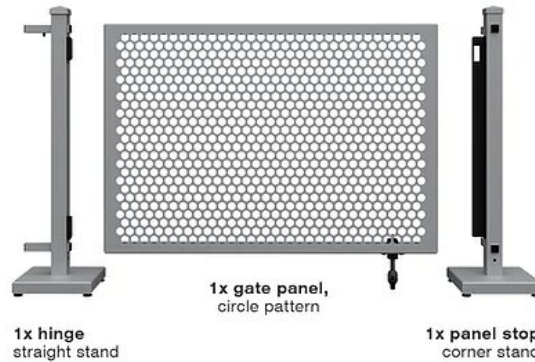
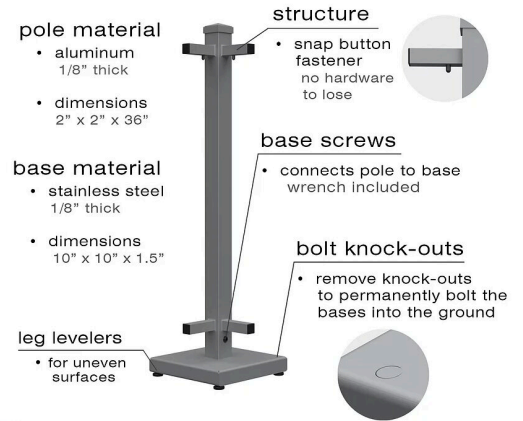
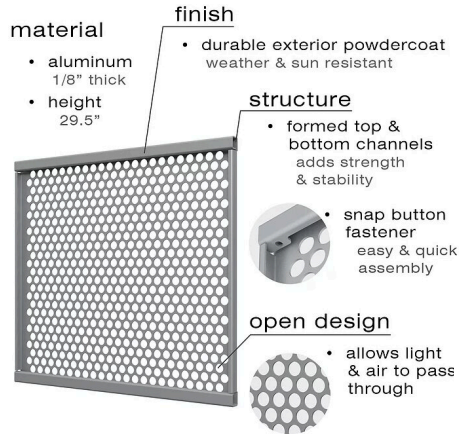

SPECIAL ORDER

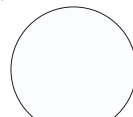

WHITE
RAL9003



GREY
RAL7040



SAND
RAL1001



BRIGHT YELLOW
RAL1023



BURNT ORANGE
RAL8023



BROWN
RAL8028



RED
RAL3003



PURPLE
RAL4005



ROYAL BLUE
RAL5002

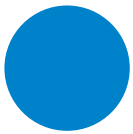

SKY BLUE
RAL5012



TEAL
RAL5018



FOREST GREEN
RAL6029



LIGHT GREEN
RAL6010

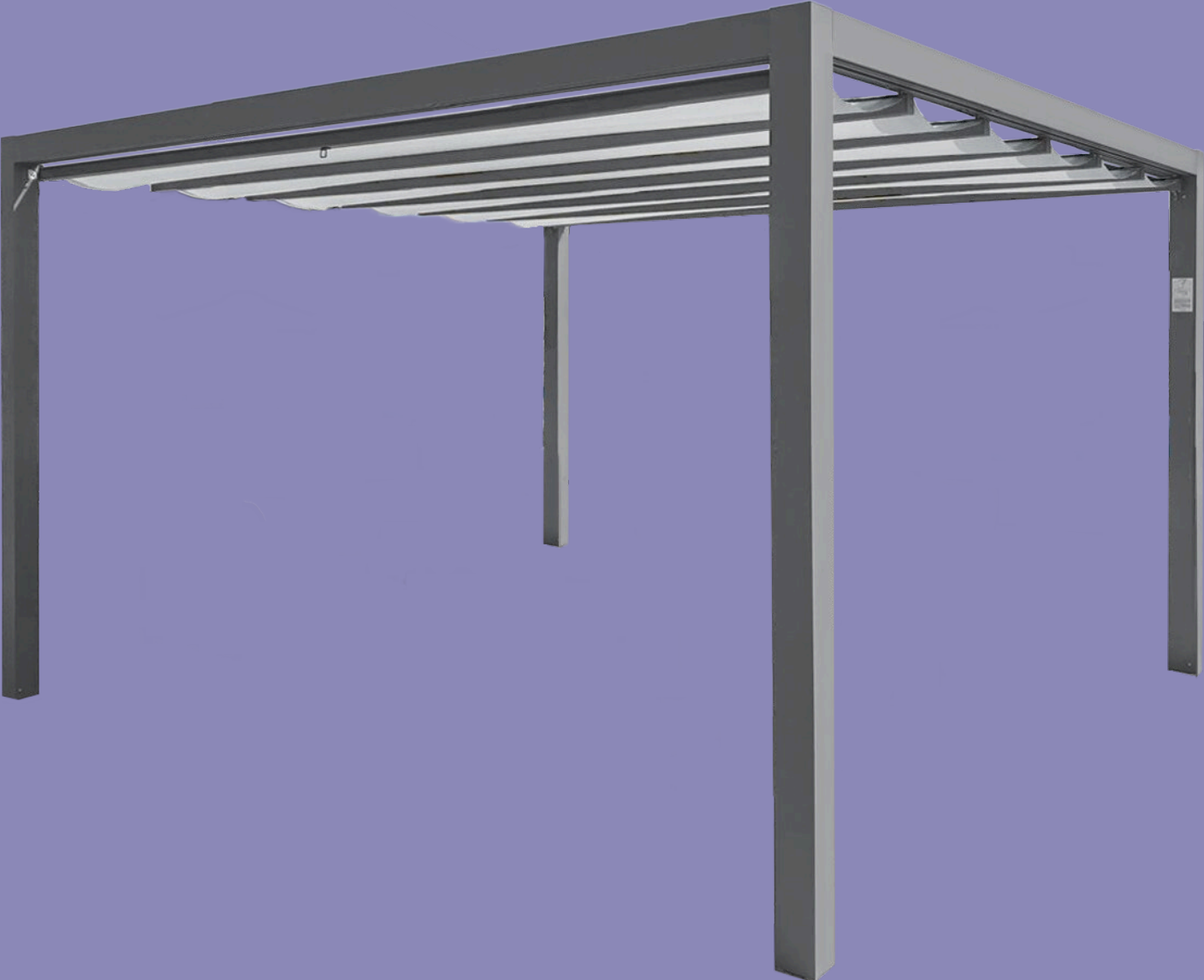

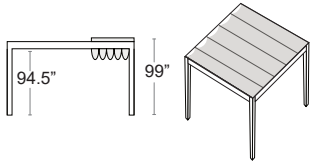

Arcadia

ASK US ABOUT WALL MOUNT OPTIONS AND CUSTOM SIZES

Arcadia Structure

Aluminum structure, Stainless steel hardware
 Cataphoresis-treated and coated with polyester powder,
 Bolt-down hardware not included,
 Attach multiple units together

Arcadia Top Cover

Ferrari Pre-Constraint 502, Heavy duty, M2 flame retardant PVC fabric,
 Pre-stressed PVC coated fabric designed for external use

Arcadia 20'x16'

*SH-GB-ARCADIA.20X16

MSRP: \$17200 EA.

SELL: \$11180 EA.

Arcadia 20'x13'

*SH-GB-ARCADIA.20X13

MSRP: \$15600 EA.

SELL: \$10140 EA.

Arcadia 20'x10'

*SH-GB-ARCADIA.20X10

MSRP: \$13600 EA.

SELL: \$8840 EA.

Arcadia 16'x13'

*SH-GB-ARCADIA.16X13

MSRP: \$13800 EA.

SELL: \$8970 EA.

Arcadia 16'x10'

*SH-GB-ARCADIA.16X10

MSRP: \$12200 EA.

SELL: \$7930 EA.

Arcadia 13x10'

*SH-GB-ARCADIA.13X10

MSRP: \$11300 EA.

SELL: \$7345 EA.

Arcadia 16'SQ

*SH-GB-ARCADIA.16SQ

MSRP: \$14800 EA.

SELL: \$9620 EA.

Arcadia 13'SQ

*SH-GB-ARCADIA.13SQ

MSRP: \$12500 EA.

SELL: \$8130 EA.

Arcadia 10'SQ

*SH-GB-ARCADIA.10SQ

MSRP: \$10400 EA.

SELL: \$6760 EA.

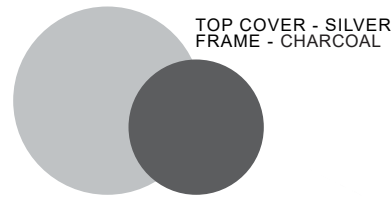

Crank Roller Blind Mesh Soltis - Charcoal

10'
*SH-GB-10SQ.RB

MSRP: \$2030 EA.

SELL: \$1220 EA.

13'
*SH-GB-13SQ.RB

MSRP: \$2480 EA.

SELL: \$1490 EA.

16'
*SH-GB-16SQ.RB

MSRP: \$2900 EA.

SELL: \$1740 EA.



Ocean Master MAX - Cantilever 10' Square

Polished aluminum frame, Offset pole, Single vent, Market cut canopy, Sunbrella Marine Grade fabric
Crank telescoping lift system, All parts are replaceable

MSRP: \$17500 EA. SELL: \$10500 EA.

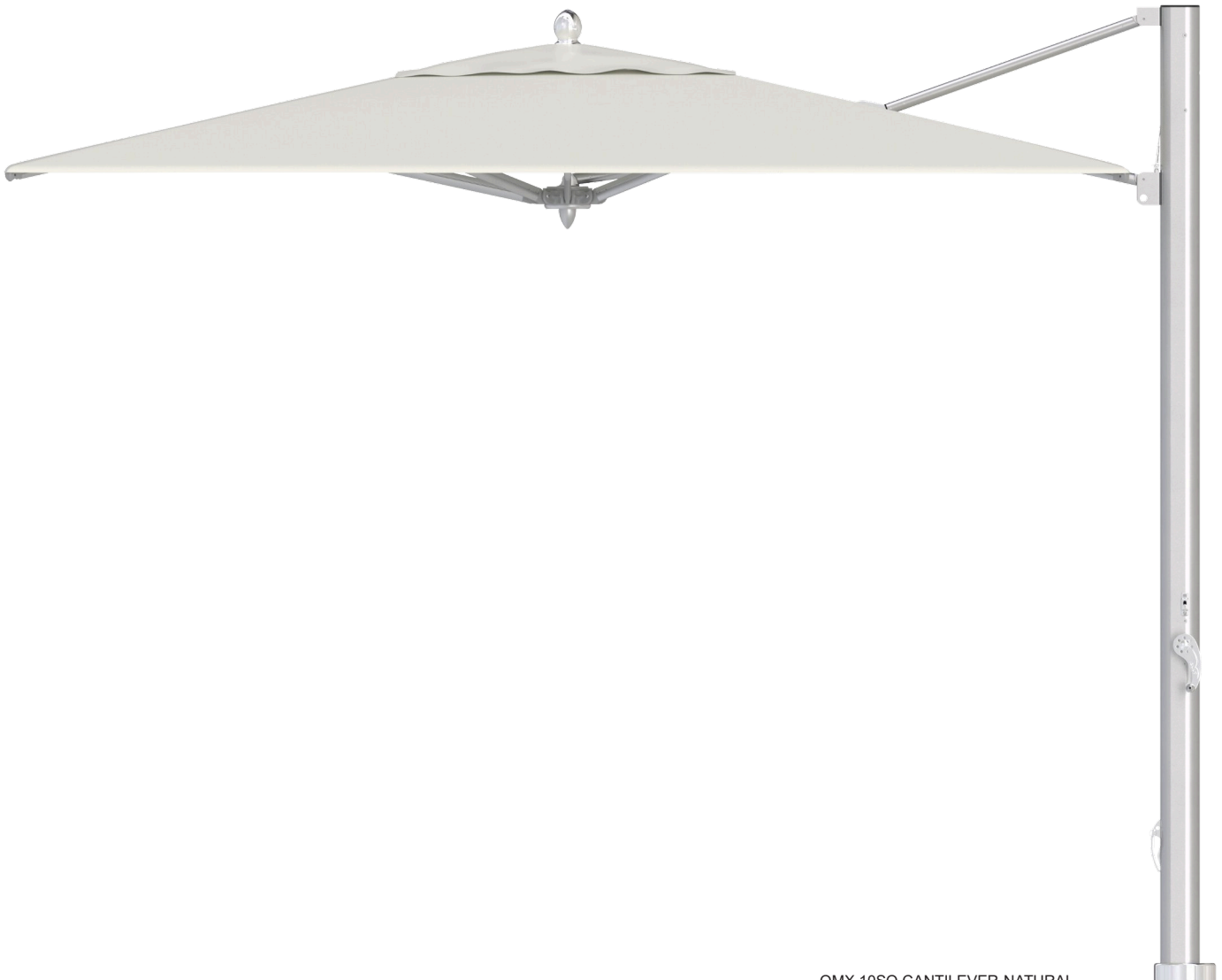
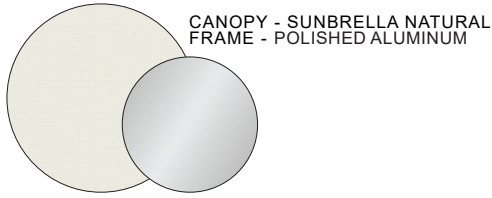
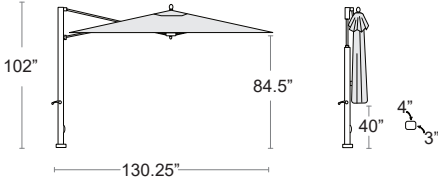

OMX 10SQ CANTILEVER-NATURAL



MAX G Umbrella Bases

MAX G Base fits with MAX collection umbrellas, Galvanized steel plates, Rounded corners, Each single plate is 1/2" Thick
Stem comes with MAX umbrella, not base

MAX G Quad Stack

800 lbs

MSRP: \$8980 EA. SELL: \$5840 EA.

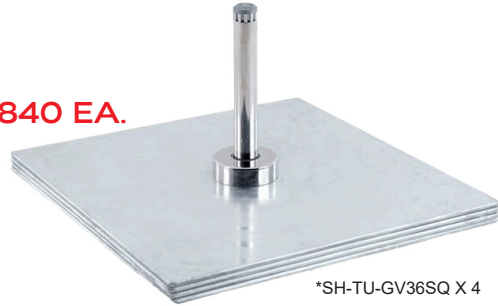

*SH-TU-GV36SQ X 4

MAX G Triple Stack

600 lbs

MSRP: \$7560 EA. SELL: \$4535 EA.



*SH-TU-GV36SQ X 3

MAX G Double Stack

400 lbs

MSRP: \$5420 EA. SELL: \$3250 EA.



*SH-TU-GV36SQ X 2

MAX On Ground Mount

To be used on existing cement surfaces
9"x9" Stainless Steel, Mounting Hardware Included

MSRP: \$1630 EA. SELL: \$980 EA.



MAXPLATE

MAX In Ground Mount

To be used on new cement only
Stainless Steel

MSRP: \$1350 EA. SELL: \$810 EA.



MAX IGSM



Oasis - 13' Octagon Cantilever

Infinity Tilt & 360 Rotation, Crank system, Matte Silver Coated Aluminum Frame, Vent, Removable High Wind Stabilizer Bar, Black Polyester Cover Included, Recacril 9 oz Marine Grade Solution Dyed Acrylic Fabric

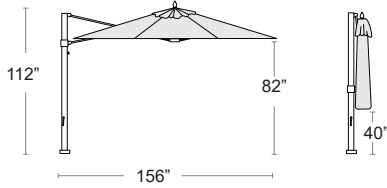

MSRP: \$6680 EA. SELL: \$4000 EA.

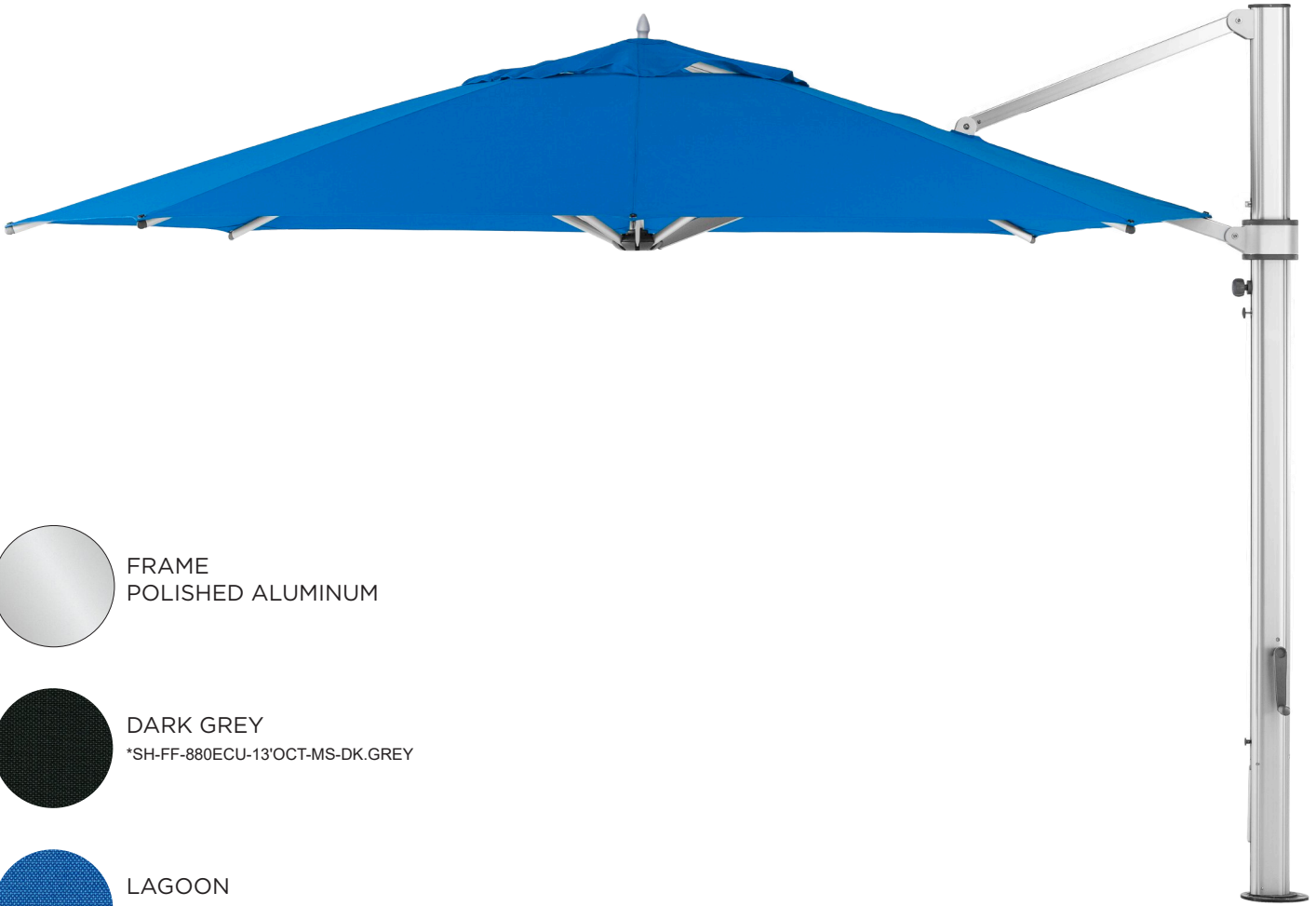

 FRAME
POLISHED ALUMINUM

 DARK GREY
*SH-FF-880ECU-13'OCT-MS-DK.GREY

 LAGOON
*SH-FF-880ECU-13'OCT-MS-LAGOON

 VERMILLION RED
*SH-FF-880ECU-13'OCT-MS-RED

 SEASHELL WHITE
*SH-FF-880ECU-13'OCT-MS-WHITE

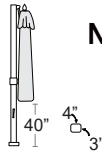
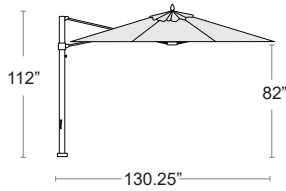

Oasis - Cantilever 10' Square

Recasens Recacril 9 oz Marine Grade Solution Dyed Acrylic Fabric, Wind stabilizer kit included, Extruded Aluminum, Stainless steel hardware, Crank lift, Infinity tilt with 360 degree rotation Protective Cover Included with Purchase

MSRP: \$6680 EA. SELL: \$4000 EA.

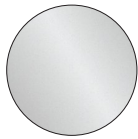

FRAME
POLISHED ALUMINUM



DARK GREY
*SH-FF-883ECU-10'SQ-MS-DK.GREY



VERMILLION RED
*SH-FF-883ECU-10'SQ-MS-RED



SEASHELL WHITE
*SH-FF-883ECU-10'SQ-MS-WHITE

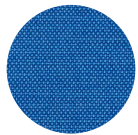

LAGOON
*SH-FF-883ECU-10'SQ-MS-LAGOON

Oasis Triple Stack with Wheels

Galvanized steel plate, Silver Dacromet coated, Triple Stacked, Hardware included, 600 LBS

MSRP: \$5400 EA.

SELL: \$3240 EA.

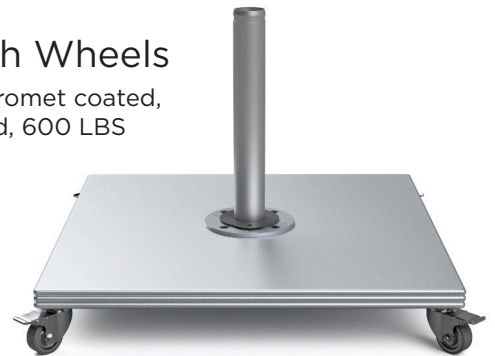

*SH-FF-OASIS-36G-SQx3+W

Oasis On Ground Mount

To be used on existing concrete or wood surfaces

Use with Oasis Cantilever 12.5" Diameter 12 lbs

MSRP: \$300 EA.

SELL: \$195 EA.



BLACK
*SH-FF-ECU-DP-BK

Oasis In Ground Stem

To be used on new cement only Galvanized Steel Use with Oasis Cantilever

MSRP: \$420 EA.

SELL: \$275 EA.



*SH-FF-ECU-IG



Bay Master 8' & 6.5' Square

Polished aluminum frame, Center pole and stem, Single vent, Market cut canopy, Sunbrella Furniture Grade fabric
Manual lift with easy grip handle, All parts are replaceable

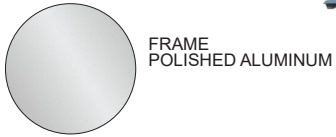

FRAME
POLISHED ALUMINUM



GRANITE



JOCKEY RED



NATURAL



BLACK

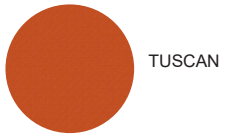

TUSCAN



MACAW



SAPPHIRE



COAL



Bay Master 8 SQ

*SH-BM8.0SQ + Colour

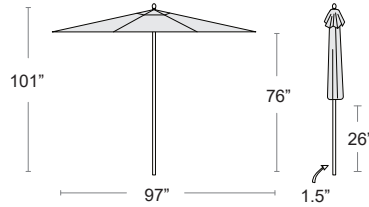

MSRP: \$2520 EA.

SELL: \$1640 EA.



Bay Master 6.5'SQ

*SH-TU-BM6.5SQ + Colour

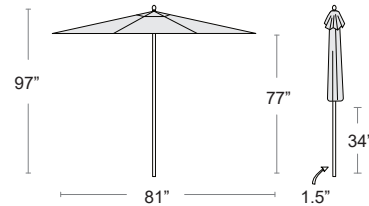

MSRP: \$1900 EA.

SELL: \$1235 EA.



G Bases

G base will fit with all Tuuci umbrellas with a 1.5" thick center pole, Galvanized steel plates, Rounded corners
Each plate is 1/2" Thick, Deck mount and hardware included,
Lock hole available on request

30" Square - 140 lbs

*SH-TU-GV30SQ

MSRP: \$1880 EA. SELL: \$1220 EA.

24" Square - 90 lbs

*SH-TU-GV24SQ

MSRP: \$1380 EA. SELL: \$900 EA.

30" Round - 105 lbs

*SH-TU-GV30RND

MSRP: \$1670 EA. SELL: \$1085 EA.

24" Round - 75 lbs

*SH-TU-GV24RND

MSRP: \$1290 EA. SELL: \$840 EA.



Aluma Crete

Aluminum shell filled with concrete, E-Plated Powder Coat silver, Stainless steel security sleeve and hardware, Fits up to 1.5" thick center pole umbrellas
Lock hole available on request

28" Round with Wheels- 150 lbs

*SH-TU-ACF150W

MSRP: \$1770 EA. SELL: \$1150 EA.

24" Round with Wheels - 95 lbs

*SH-TU-ACF95W

MSRP: \$1450 EA. SELL: \$945 EA.

28" Round - 150 lbs

*SH-TU-ACF150

MSRP: \$1300 EA. SELL: \$845 EA.

24" Round - 95 lbs

*SH-TU-ACF95

MSRP: \$1000 EA. SELL: \$650 EA.

20" Round - 65 lbs

*SH-TU-ACF65

MSRP: \$880 EA. SELL: \$575 EA.





In Ground Flush Mount

Stainless steel ground flush mount, Comes with aluminum extension pole
 Fits 1.5" thick center pole umbrellas, Mounting hardware included, 6 lbs
 Lock hole available on request

MSRP: \$1070 EA. SELL: \$700 EA.



*SH-TU-FLUSHMT



Deck Mount

Stainless steel Fits 1.5" thick center pole umbrellas,
 Star knob locking system, 4 lbs
 Lock hole available on request

MSRP: \$450 EA. SELL: \$295 EA.



*SH-TU-DECKMNT



Umbrella Locks

MSRP: \$36 EA. SELL: \$22 EA.

Cable Lock

14" Cable Lock
 *SH-TU-CABLE LOCK



Master Lock

*SH-TU-LOCK





Oasis 6' x 9' Rectangle

Recasens Recacril 9 oz Marine Grade Solution Dyed Acrylic Fabric, Brushed aluminum frame with single wind vent, 2 piece center pole, Stainless steel hardware, Manual lift with pin

MSRP: \$1120 EA. SELL: \$730 EA.

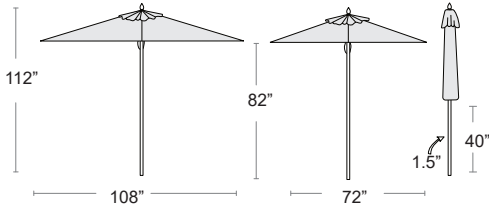

DARK GREY
*SH-FF-OASIS-6'x9'-DARK.GREY



VERMILION
*SH-FF-OASIS-6'x9'-RED



SEASHELL
*SH-FF-OASIS-6'x9'-WHITE



 SPECIAL ORDER

CUSTOM COLOUR FABRIC

*SH-FF-OASIS-6' X 9'-FRAME + FABRIC CODE
info@bumoutdoor.ca for options

MSRP: \$1490 EA. SELL: \$970 EA.



Oasis 7.5' Square

Recasens Recacril 9 oz Marine Grade Solution Dyed Acrylic Fabric, Brushed aluminum frame with single wind vent, 2 piece center pole, Stainless steel hardware, Manual lift with pin

MSRP: \$1000 EA. SELL: \$650 EA.

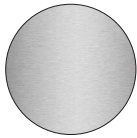
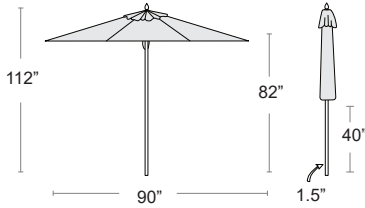

FRAME
BRUSHED ALUMINUM

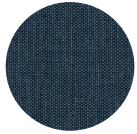

DENIM BLUE
*SH-FF-OASIS-7.5'SQ-BLUE



DARK GREY
*SH-FF-OASIS-7.5'SQ-DARK.GREY



VERMILION
*SH-FF-OASIS-7.5'SQ-RED



TITANIUM
*SH-FF-OASIS-7.5'SQ-TITAN.GREY



SEASHELL
*SH-FF-OASIS-7.5'SQ-WHITE



SPECIAL ORDER

CUSTOM COLOUR FABRIC

*SH-FF-OASIS-7.5'SQ-FRAME + COLOUR CODE
info@bumoutdoor.ca for options

MSRP: \$1410 EA. SELL: \$915 EA.



Oasis 9' Octagon

Recasens Recacril 9 oz Marine Grade Solution Dyed Acrylic Fabric, Brushed aluminum frame with single wind vent, 2 piece center pole, Stainless steel hardware, Manual lift with pin

MSRP: \$960 EA. SELL: \$625 EA.

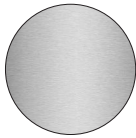
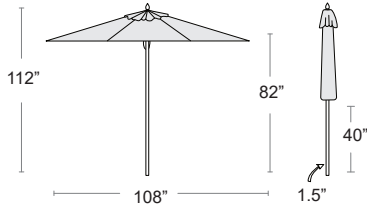

FRAME
BRUSHED ALUMINUM

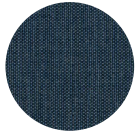

DENIM BLUE
*SH-FF-OASIS-9'OCT-BLUE



DARK GREY
*SH-FF-OASIS-9'OCT-DARK.GREY



VERMILION
*SH-FF-OASIS-9'OCT-RED



TITANIUM
*SH-FF-OASIS-9'OCT-TITAN.GREY



SEASHELL
*SH-FF-OASIS-9'OCT-WHITE



SPECIAL ORDER

CUSTOM COLOUR FABRIC

*SH-FF-OASIS-9'OCT-FRAME + COLOUR CODE
info@bumoutdoor.ca for options

MSRP: \$1300 EA. SELL: \$845 EA.



Aluminum Concrete

Aluminum E-Plated Powder Coat Shell Filled with Concrete - Wheels - Brushed Silver - 18" Stem - 1.5" Diameter - 2 Locking Points

150A Round with Wheels - 150 lbs

*SH-FF-150A/18ST2-MS

MSRP: \$1370 EA. SELL: \$890 EA.

100A Round with Wheels - 100 lbs

*SH-FF-100A/18ST-MS

MSRP: \$880 EA. SELL: \$570 EA.



Bum Galvanized Steel Bases

Galvanized Steel Base - 1/2" Thick - 18" High Stem - 2 Locking Points

30" Round - 100 lbs

*SH-FF-30G/18ST-GS

MSRP: \$1270 EA. SELL: \$825 EA.

24" Round - 70 lbs

*SH-FF-24G/18ST-GS

MSRP: \$1020 EA. SELL: \$665 EA.

24" Square - 100 lbs

*SH-FF-24G-SQ/18ST-GS

MSRP: \$1150 EA. SELL: \$750 EA.

20" Square - 70 lbs

*SH-FF-20G-SQ/18ST-GS

MSRP: \$1020 EA. SELL: \$665 EA.





Oasis 24" SQ Steel Base with Wheels

E-Plated Powder Coat finish, Silver Mist, 2 stationary wheels, 16" threaded stem
Fits 1.5" Umbrella pole, 2 locking points, 4 holes to bolt down if required

MSRP: \$570 EA. **SELL: \$370 EA.**



SILVER MIST
*SH-FF-OASIS-75S-SM



Oasis 80 Lb Coated Concrete Base

Resin coated concrete base, 2 locking points,
bottom ring can be bolted to a surface

MSRP: \$280 EA. **SELL: \$185 EA.**

MATTE SILVER
*SH-FF-OASIS-23-MS



Additional 35 Lb Ring

MSRP: \$170 EA. **SELL: \$110 EA.**

MATTE SILVER
*SH-FF-OASIS-23-R

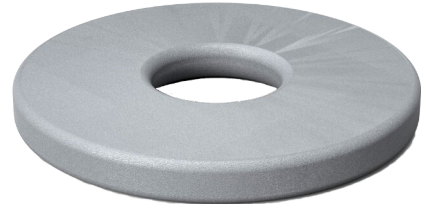

Oasis 50 Lb Coated Concrete Base

Resin coated concrete base

USE WITH TABLE ONLY NOT FREE STANDING

MSRP: \$190 EA. **SELL: \$125 EA.**

MATTE SILVER
*SH-FF-50C-MS





SHADE



PLANTERS



Hedge Planter Set

E-Coated Steel Frame withstands harsh outdoor weather, Great for privacy, Outdoor 3-year warranty, Strong wind resistance
 Manufactured to ISO 9001 standards, SGS-certified artificial foliage
 UV protection, Durable, movable, and reusable
 Wheels available.

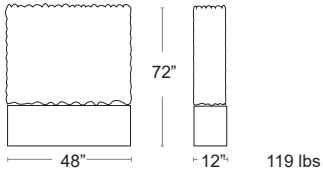

Hedge Planter Set 6'

MSRP: \$2000 EA.
SELL: \$1300 EA.

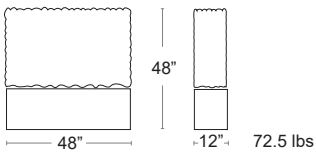

*P-BUM-HEDGE 6'

MSRP: \$50 EA.
SELL: \$25 EA.



*P-BUM-HEDGE WHEELS 4PK

Hedge Planter Set 4'

MSRP: \$1420 EA.
SELL: \$925 EA.

Hedge Connectors

Connects two planters together for extra stability

NET: \$5 EA.



*P-BUM-HEDGE CONNECTOR



*P-BUM-HEDGE 4'



Bamboo Artificial Tree

Bamboo artificial tree with green leaves. Realistic detail integrated injection process leaves and stems are one piece.

Manufactured to ISO 9001 standards, SGS-certified artificial foliage UV protection, Durable, movable, and reusable



Bamboo Tree 80"

*P-BUM-BAMBOO-80"

MSRP: \$120 EA.

SELL: \$75 EA.

Bamboo Tree 60"

*P-BUM-BAMBOO-60"

MSRP: \$80 EA.

SELL: \$50 EA.



PLANTERS



Kabin Planters

LLDPE (linear low-density polyethylene) achieved by rotational molding. UV protection. 100% recyclable, High degree of mechanical strength and resistance to impacts,

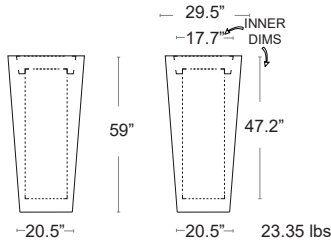

Kabin Extra

MSRP: \$2460 EA.
SELL: \$1600 EA.

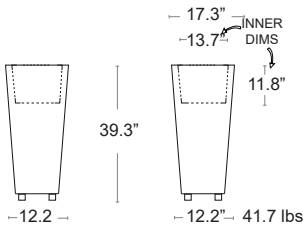

Kabin Maxi

MSRP: \$1050 EA.
SELL: \$685 EA.

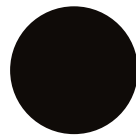

ANTRACITE

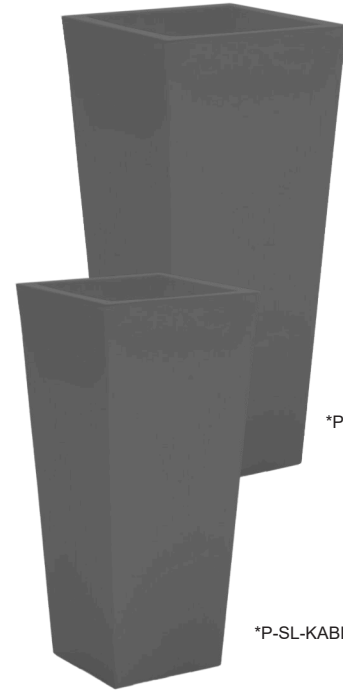

*P-SL-KABINEXTRA-ANT

*P-SL-KABINMAXI-ANT

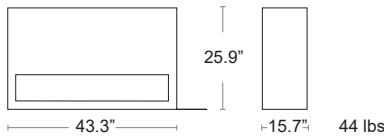

Lluna Planters

LLDPE (linear low-density polyethylene) achieved by rotational molding. UV protection. 100% recyclable, High degree of mechanical strength and resistance to impacts, Lacquered finish, Resistant to temperatures, - 35°C - 80°C.

Lluna 110

MSRP: \$1470 EA.
SELL: \$955 EA.



*P-SL-LLUNA 110-ANT

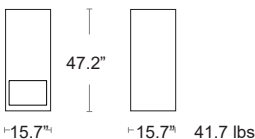

Lluna Nova

MSRP: \$1270 EA.
SELL: \$830 EA.



ANTRACITE



*P-SL-LLUNA NOVA-ANT

PLANTERS



Neoclassic

LLDPE (linear low-density polyethylene) achieved by rotational molding. UV protection. 100% recyclable, High degree of mechanical strength and resistance to impacts, Textured finish

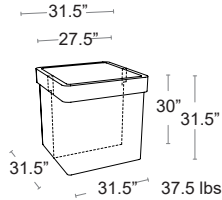

Neoclassic Quadro

MSRP: \$1260 EA.
SELL: \$820 EA.

*P-SL-NEOCLASSIC-788-ANT



Neoclassic Cassetta

MSRP: \$540 EA.
SELL: \$350 EA.

*P-SL-NEOCLASSIC-710-ANT

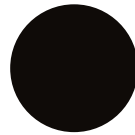
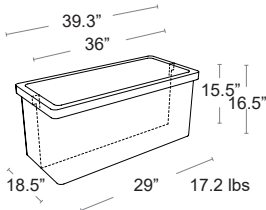

ANTRACITE



Fence

LLDPE (linear low-density polyethylene) achieved by rotational molding. UV protection. 100% recyclable, With galvanized steel reinforcement High degree of mechanical strength and resistance to impacts, Matte finish Resistant to temperatures, - 35°C - 80°C.

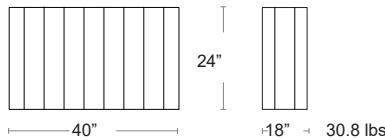

Fence Large

MSRP: \$1080 EA.
SELL: \$700 EA.

*P-SL-715-ANT

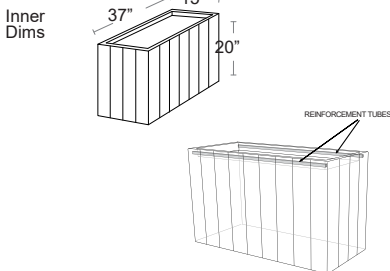
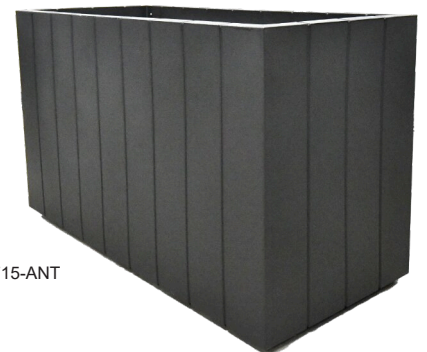

Fence Small

MSRP: \$400 EA.
SELL: \$260 EA.

*P-SL-715 SMALL-ANT

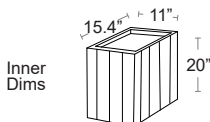
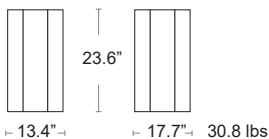

ANTRACITE



PLANTERS



SERRALUNGA

Newpot Planters

Rotational molded resin planter, UV Protected, Can handle -40C to +40C
Suitable for both outdoor and indoor use.

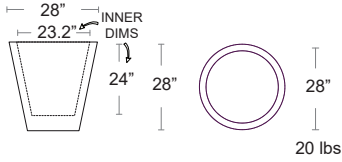

Newpot 70

*P-SL-NEWPOT70 + COLOUR

MSRP: \$890 EA.

SELL: \$580 EA.

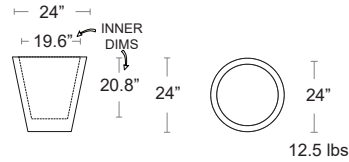

Newpot 60

*P-SL-NEWPOT60 + COLOUR

MSRP: \$660 EA.

SELL: \$430 EA.

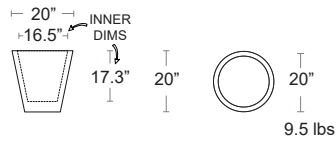

Newpot 50

*P-SL-NEWPOT50 + COLOUR

MSRP: \$510 EA.

SELL: \$335 EA.



ANTRACITE
ANT

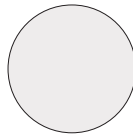

WHITE
WH



SERRALUNGA

Torre 755

LLDPE (linear low-density polyethylene) achieved by rotational molding. UV protection.
100% recyclable. High degree of mechanical strength and resistance to impacts,
Lacquered finish Resistant to temperatures, minus 35°C plus 80°C.

MSRP: \$840 EA. SELL: \$545 EA.

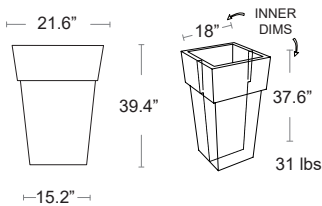

ANTRACITE
*P-SL-TORRE 755-ANT



PLANTERS



NARDI
YOUR OUTDOOR LIVING

Sipario Self Watering Planter System  **regeneration**
Modular Partition wall system, Polypropylene resin, Self watering planter,
UV Protected
GREEN GOOD DESIGN AWARD 2021

Sipario 3

*P-Nar-40395 + COLOUR

MSRP: \$680 EA.

SELL: \$445 EA.

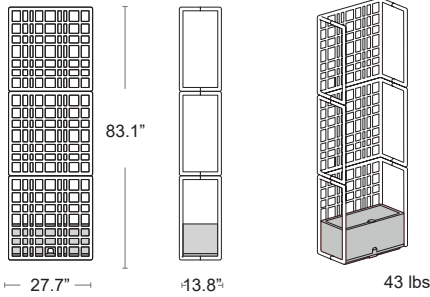

Sipario 2

*P-Nar-40394 + COLOUR

MSRP: \$510 EA.

SELL: \$335 EA.

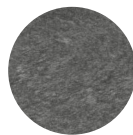
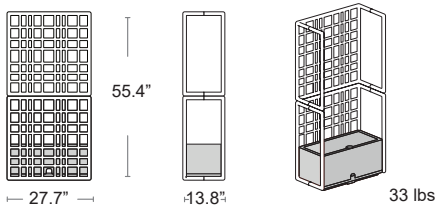

BASALTO
25

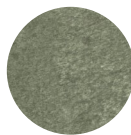

CACTUS
27

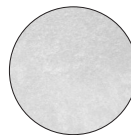

GESSO
29

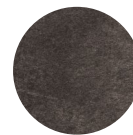

TERRA
44

PLANTERS



Vaso Rettangolare

LLDPE (linear low-density polyethylene) achieved by rotational molding. UV protection. 100% recyclable. High degree of mechanical strength and resistance to impacts, Resistant to temperatures, minus 35°C plus 80°C.

MSRP: \$620 EA. SELL: \$405 EA.

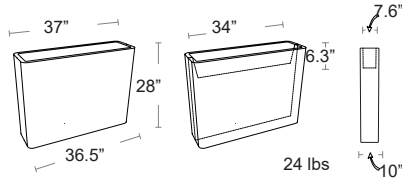

ANTRACITE
*P-SL-722-ANT



Cubotti

LLDPE (linear low-density polyethylene) achieved by rotational molding. UV protection. 100% recyclable. High degree of mechanical strength and resistance to impacts, Resistant to temperatures, minus 35°C plus 80°C.

MSRP: \$530 EA. SELL: \$345 EA.

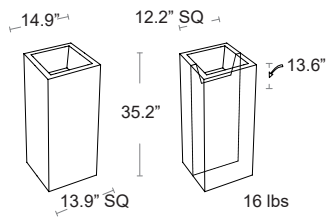

ANTRACITE
*P-SL-722-ANT





Moderne Propane Commercial Fire Table

Fiberglass reinforced cast concrete, Stainless steel burner, Electronic Ignition
 60,000 BTU professional burner system,
 Auto flame out for safety, Includes levelers for stability
 Includes Burner Cover, Glass Windscreen & Propane Tank Cover

MSRP: \$6200 EA. SELL: \$3720 EA.

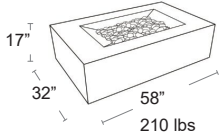

Propane Tank Cover/Side Table or Seat

Fiberglass reinforced cast concrete

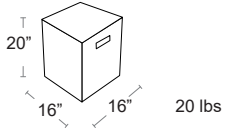

Tempered Glass Wind Screen 38" x 24"



Aluminum Burner Cover



CHARCOAL
 PYROMANIA MODERNE SET - PROPANE



Moderne Natural Gas Commercial Fire Table

Fiberglass reinforced cast concrete, Stainless steel burner, Electronic Ignition
60,000 BTU professional burner system,
Auto flame out for safety, Includes levelers for stability
Includes Burner Cover, Glass Windscreen

MSRP: \$5600 EA. SELL: \$3640 EA.

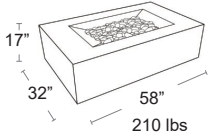

Tempered Glass Wind Screen 38" x 24"



Aluminum Burner Cover





Natural Gas Conversion Kit

*F-NP-S85004

SOLD SEPARATELY FOR ALL MODELS

MSRP: \$250 EA.

SELL: \$165 EA.

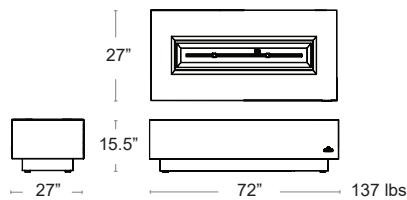

Nexus Flame Table 72"

Cast aluminum construction that looks like formed concrete. Premium stainless steel burner with lava rock media, Cover included, 53,000 BTU's SOLD AS A COMPLETE SET 10' propane hose, All weather cover

MSRP: \$4155 EA. SELL: \$2700 EA.



NEXUS.72 SET

Nexus Flame Table 56"

Cast aluminum construction that looks like formed concrete. Premium stainless steel burner with lava rock media, Cover included, 53,000 BTU's SOLD AS A COMPLETE SET 10' propane hose, All weather cover

MSRP: \$3230 EA. SELL: \$2100 EA.



NEXUS.56 SET

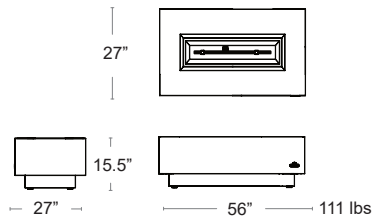

Nexus Flame Table 36"

Cast aluminum construction that looks like formed concrete. Premium stainless steel burner with lava rock media, Cover included, 53,000 BTU's SOLD AS A COMPLETE SET 10' propane hose, All weather cover

MSRP: \$2460 EA. SELL: \$1600 EA.



NEXUS.36 SET

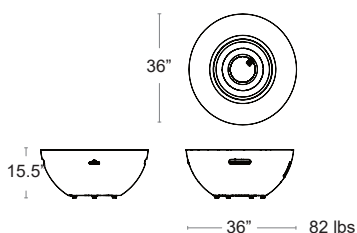



St Tropez

Rectangular and Square Linear Design Patio Flame Tables
 All aluminum construction, Propane tank can be hidden inside the table
 Stylish glass ember bed, Easy start electronic ignition, 60,000 BTU of Heat
 Thermo-couple valve shuts off gas supply if flame is extinguished
 Stainless steel 10"x 30" pan burner
 Comes complete with lid for burner and natural gas conversion kit
COVER AND GLASS WINDSCREEN INCLUDED WITH TABLE

MSRP: \$2920 EA. SELL: \$1900 EA.

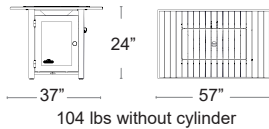

RECTANGLE
 RUSTIC BRONZE
 ST. TROPEZ RECT. FLAME SET

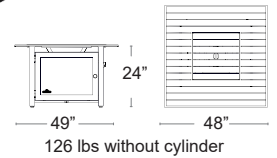

SQUARE
 RUSTIC BRONZE
 ST. TROPEZ SQUARE FLAME SET



Hampton

Rectangular and Square Linear Design Patio Flame Tables
 All aluminum construction, Propane tank can be hidden inside the table
 Stylish glass ember bed, Easy start electronic ignition, 40,000 BTU of Heat
 Thermo-couple valve shuts off gas supply if flame is extinguished
 Stainless steel pan burner
 Comes complete with lid for burner and natural gas conversion kit
COVER AND GLASS WINDSCREEN INCLUDED WITH TABLE

MSRP: \$2620 EA. SELL: \$1700 EA.

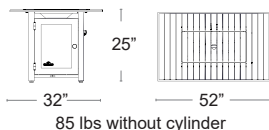

RECTANGLE
 GREY
 HAMPTON RECT. FLAME SET

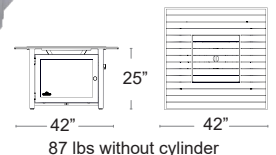

SQUARE
 GREY
 HAMPTON SQUARE. FLAME SET

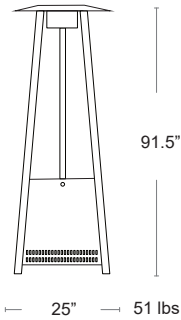

Pyramid Heater

Quartz Tube Tower Heater made to withstand all commercial applications,
 42,000 BTUH
 Heat range of up to 10' diameter,
 Piezo Push -button ignition
 Variable gas control valve,
 Standard 20 Lb and 30 Lb propane tank compatible
 304 stainless steel body, wire mesh and hardware
 Fused tempered quartz glass,
 Aluminum Frame
 Larger steel reflector,
 Flame height adjustment control knob
 Wheels designed for easy mobility
 Propane tank not included

MSRP: \$800 EA. SELL: \$520 EA.



*F-BUM-FSD-C-SS

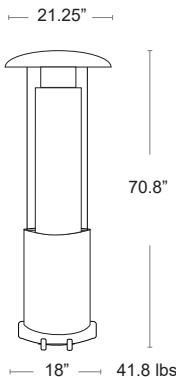

Commercial Tube Heater

Heavy duty stainless steel body,
 Weather resistant,
 Anti-Tilt Switch
 Auto Shut Off
 Holds standard 20lb propane tank
 10+ Hours of burn time on High
 Wheels, Hose & Regulator included,
 ETL Certified
 Easy on/off tank access
 High output and fuel efficient burner
 44,382 BTU
 Propane tank not included

MSRP: \$730 EA. SELL: \$475 EA.



*F-BUM-FSD-E-SS



Comfort Plus Infrared Heater

Provides up to 64 square feet of radiant warmth ,
 90% efficiency in converting energy into directional, virtually wind-proof heat.
 Weatherproof, stainless steel construction
 Operate safely in all weather conditions, cETLus certified

SUITABLE FOR WALL OR CEILING MOUNTING,
 REMOTE CONTROL INCLUDED WITH ALL MODELS
 BATTERIES NOT INCLUDED

Aura 3000W - 208/240V Wall/Ceiling Mount

MSRP: \$1020 EA. **SELL: \$600 EA.**

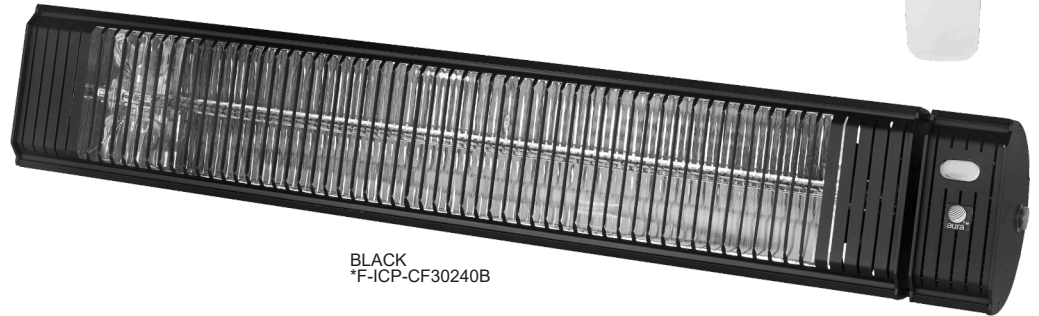
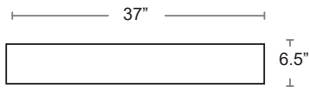

BLACK
 *F-ICP-CF30240B

Aura 1500W - 120V Wall/Ceiling Mount

MSRP: \$810 EA. **SELL: \$485 EA.**

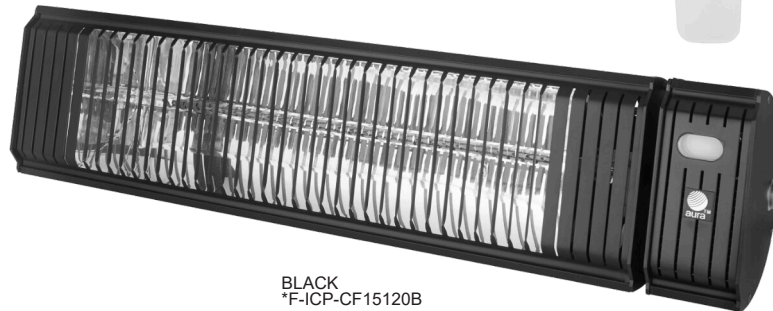
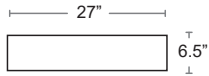

BLACK
 *F-ICP-CF15120B

SWATCHES

Resin Finishes



Table Bases

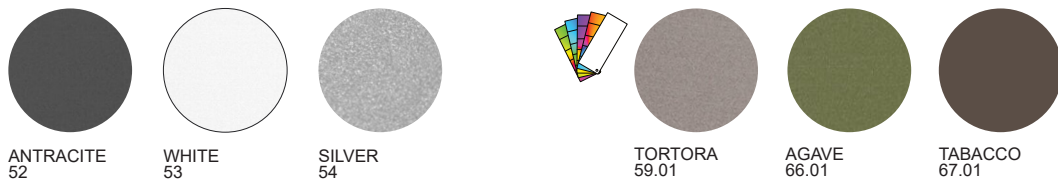

Nardi Cushions

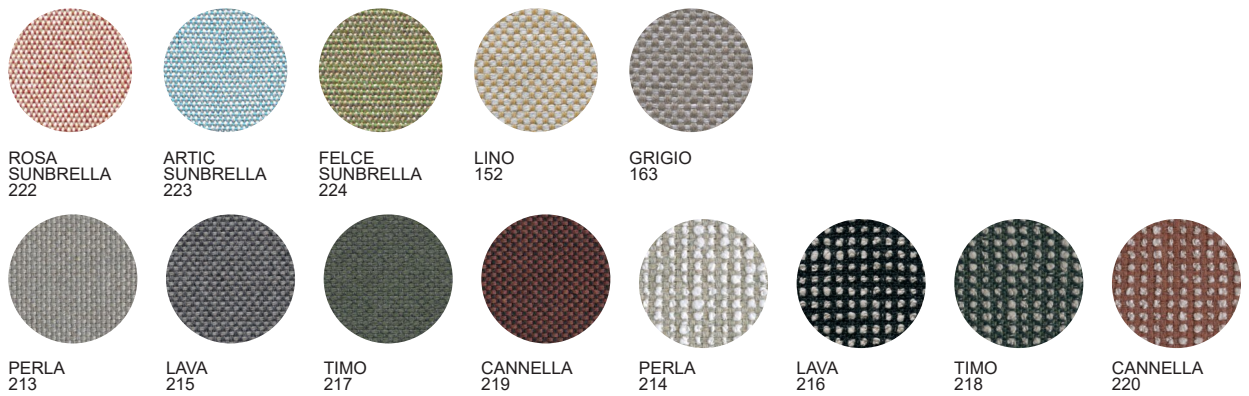

Sling Fabric - Atlantico

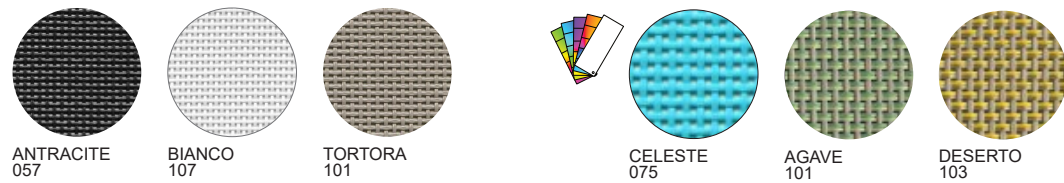

Sling Fabric - Alfa/Omega



SWATCHES



Resin Finishes - Made in Canada

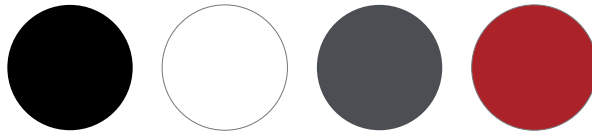

BLACK WHITE CHARCOAL RED



GOLDEN YELLOW LIME GREEN FOREST GREEN COBALT SKY BLUE TAN LEATHER CHOCOLATE



Resin Finishes



ANTRACITE WHITE LIGHT GREY LIGHT YELLOW RED TORTORA OLIVE GREEN

Lacquer Finishes

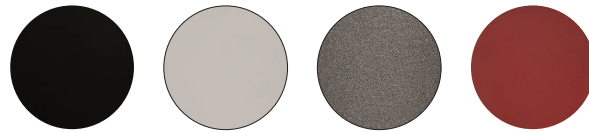

BLACK -LBK WHITE -LWH ANTRACITE -LAN RED -LRO



Cushions and Toss Pillows

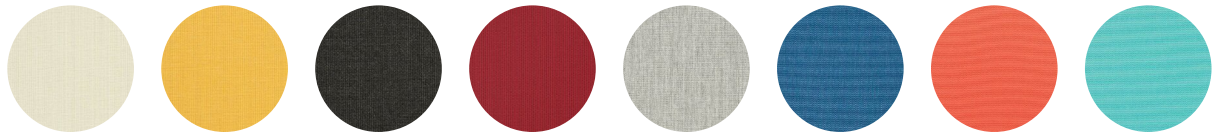

SPECTRUM EGGSHELL 48018 SPECTRUM DAFFODIL 48024 SPECTRUM CARBON 48085 SPECTRUM CHERRY 48096 CANVAS GRANITE 5402 CANVAS REGATTA -5493 CANVAS MELON -5415 CANVAS ARUBA -5416



CANVAS PALM -5421 DOLCE MANGO -56000 DOLCE OASIS -56001 PEYTON GRANITE 56075 MILANO CHAR 56079 CABANA REGATTA -58029 CABANA CLASSIC -58030



Marco Finishes

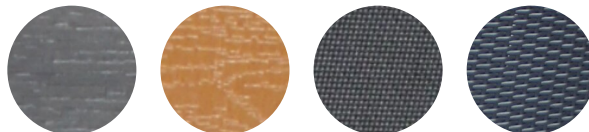

GREY TEAK BATYLINE VIRO WICKER

Marco Frames

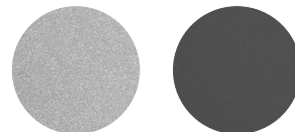

SILVER ANTRACITE

Parisian

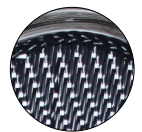

BLACK/WHITE

Lounge Cushions

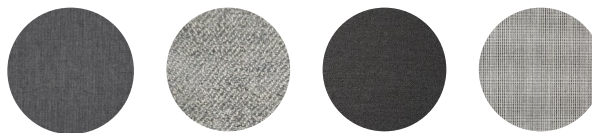

CAST CHARCOAL VENUS DOLPHIN VENUS STEEL VOLT SILVER

Lounge Frame Finish



SKYLINE ALL WEATHER WICKER URBAN BLACK CITY VIEW ANTRACITE

SWATCHES

Tabletop Finishes



JAKARTA
TEAK



Bum Exteriolit Classic
Bum Compact HPL



EXTERIOLIT
MARBLE
PIETRO

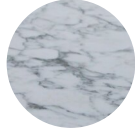

EXTERIOLIT
MARBLE
CARRARA



EXTERIOLIT
ATRIUM
GREY



EXTERIOLIT &
COMPACT HPL
SILVER FABRIC



COMPACT HPL
VINTAGE
PINE



COMPACT HPL
VINTAGE
FLEETWOOD



Bum Classic

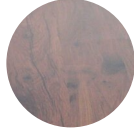

ANTIQUÉ
OAK



PINIE



PONDEROSA
GREY



PONDEROSA
WHITE



STRATTOS

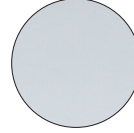

BIANCO



Metal Finishes



YELLOW
1002

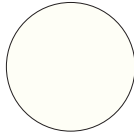

WHITE
1310



ORANGE
2012



GREEN
6021



BLUE
6034

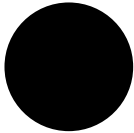

BLACK
9005



RED
3169



Metal Finishes



MARINE BLUE
-16



IRON
-22



WHITE
-23



BLACK
-24



MAPLE RED
-26



BRONZE
-41

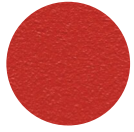

CHERRY
-50



CEMENT
-73



CURRY
YELLOW
-62

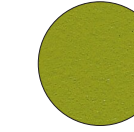

GREEN
-60



BLUE
-61

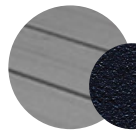

GREY/BLACK
24-400



OAK/ALUM
06-40

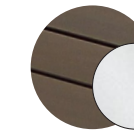

WENGE/ALUM
06-402



WALNUT/IRON
22-404

Lounge Seating Frames



07 BRONZE +
19 BROWN
SYNTHETIC
ROPE



04 DARK GREY +
12 GREY
SYNTHETIC
ROPE



02 WHITE +
18 DARK GREY
SYNTHETIC
ROPE

Lounge Seating Cushions



CANVAS
HAZE



CANVAS
GRANITE



CAST
PUMICE

SWATCHES

Umbrella Canopies



GRANITE



JOCKEY RED



NATURAL



BLACK

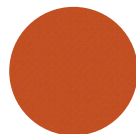

TUSCAN



MACAW



SAPPHIRE

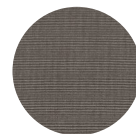

COAL

Umbrella Frame

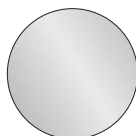

POLISHED ALUMINUM



Umbrella Canopies

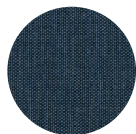

DENIM BLUE
232



DARK GREY
150



VERMILION
182



TITANIUM
196



SEASHELL
122

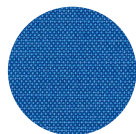

LAGOON
296

Umbrella Frame

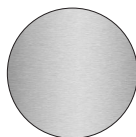

BRUSHED ALUMINUM

Moderne Flame Finishes



CHARCOAL



STAINLESS STEEL



Flame Finishes



ST. TROPEZ
RUSTIC
BRONZE

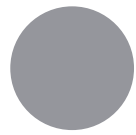

HAMPTON
GREY

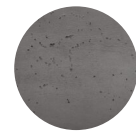

NEXUS
CONCRETE
FINISH

TERMS & CONDITIONS

TERMS & CONDITIONS

Product Dimensions/Information

All dimensions and weights shown are to be considered approximate as the majority of the products are manufactured in countries using the metric system; most measurements are converted from metric units. Bum Commercial Furniture (hereon referred to as "Bum" / "we") reserves the right to make improvements to information displayed in our catalogue as well as our website without prior notice.

Please note that all finishes on our marketing materials and website are approximate due to variation in colour monitors and the processes of photography and printing.

Assembly

Some products require assembly; please refer to the instructions included with item packaging or visit our website for information on assembly instructions. If instructions are not available, please contact info@bumoutdoor.ca

Availability

Bum orders items in this catalogue continuously based on historical values; depending on quantity, Quick Ship items should be readily available in stock, however, may have an extended lead time in case of current sell-out, or material shortages. We strive to keep substantial quantities of our bestsellers in stock at all times.

Special Order

Bum has access to many items outside of our Quick Ship catalogue. Special order can be placed through Bum, however those items do have a significantly longer lead time, sometimes up to 22 months for items from EMU. Please note that all special order items require a special order form to be signed as well as a 25% deposit taken (in some cases). Once orders are placed, they cannot be cancelled. Customer is responsible for 100% payment of product cost if cancelled.

Pricing

All prices published are MSRP and SELL per single unit, and do not including shipping costs, taxes or installation. Due to frequent currency and raw material fluctuations, we reserve the right to change prices without notice.

All Bum Commercial Furniture dealers (brick and mortar and online) must not sell our products for less than the sell price listed in our current year Quick Ship catalogue and website.

Quotes

Please contact your local Bum Commercial Furniture representative for quotes. For a local rep please contact info@bumoutdoor.ca. All quotations received from Bum Commercial Furniture or our sales representatives are valid for 30 days unless prolonged in writing.

Sample Requests

Fill out the sample request form on our website <https://bumoutdoor.ca/sample-request/>. Bum has the right to deny sample requests if they see fit.

Placing of Orders

All orders are to be sent to orders@bumoutdoor.ca with your sales representative on CC (if applicable). Orders must be sent in the form of a formal purchase order. These orders are subject to acceptance by Bum. All orders must contain the following information:

Bill to + contact name and phone number

Ship to + contact name and phone number

Proper product codes, colours and quantity required

Requested ship date or required on site date and shipping requirements (i.e. call before, appointment delivery, tailgate delivery, white glove services) and/or state that customer is picking up (Bum does not guarantee delivery by those dates but will do their best to accommodate)

Purchase order number or code

Acknowledgement

Order acceptance will be made in the form of a sales order confirmation. This confirmation will include an estimated ship date based on dates the customer has provided. If they are not provided, the "date required" will be noted as the date of the sales order entry. The sales order will also include lead times/estimated warehouse arrivals (EWA) listed on each line item if applicable.

Sales Order Confirmations must be reviewed for corrections immediately upon receipt. There will be a link provided in which the customer must click and "approve" the order. Without that being done, the order is not yet confirmed and valid. Bum will not be held responsible for any errors or missing information on sales order confirmations. All orders will ship ASAP unless otherwise noted on the purchase order. Please note: if an order is split shipped, backorder shipping charges will apply.

Accepting the order confirmation online is the customers' acceptance of all these terms.

Once shipped, invoices are sent via email with tracking information on the day of the shipment.

Backorders

Standard shipping charges apply to all backorders. All backorders will ship once the product becomes available.

Payments & Credit

Payment Methods Accepted: EFT / ACH / Company Cheques / E-transfers / Credit Cards (fees may apply).

Returned cheques are subject to a \$100 fee NSF fee.

Required Deposits

Each of the following requires a 25% non-refundable deposit and/or a special order form being signed:

Special Order Items

Direct Containers

Clearance Items

In the case where terms have been established with Bum, only the form is required (aside from clearance items).

Deductions

No deductions may be made from remittance without email authorization from Bum Commercial Furniture.

Collections

In the event of delinquency, the customer shall be responsible for all collection costs, including attorney's fees incurred by Bum Commercial Furniture.

Refunds

Should a refund be required due to overpayment, this may only be processed after the completion of the related purchase order. The completion of the purchase order is when the order is shipped and invoiced.

Returns

Special order items, parts, clearance, and cushions are not returnable and non-refundable.

QuickShip items may be returned within 30 days from the invoice date with an RMA (return merchant authorization). Items must be received in their original condition, in original boxes including all original interior packaging, and palletized for a full refund (or brought directly back to the warehouse for a full refund minus a 25% restocking fee.

Re-Stocking Fee

A minimum of 25% restocking fee will be charged for the return of Quick Ship items in their original condition.

Credit for returns will only be issued after receipt and inspection of returned merchandise. Damaged returns are subject to additional charges incurred to restore goods to their original condition or the customer may reclaim the items if the determined credit amount is insufficient.

No return of merchandise will be accepted to our distribution centre without our email consent and RMA number, which includes the appropriate shipping instructions. Unauthorized returns will be refused and/or returned freight collect.

RMA # is only valid for 15 days from the issue date. A copy of the RMA must accompany the returned merchandise, and the RMA # must appear on each carton returned. Any additional cartons needed for return will be charged to your account. No credit will be issued for goods without our email consent.

Estimated Ship Date

All estimated ship dates are approximate only. Bum cannot be held responsible for financial damage due to late shipping. All orders are subject to delay or failure of delivery due to problem with source of supply, transportation, war, riots, fire, accidents, compliance with government regulations, strikes, Acts of God, or other causes beyond our control.

Shipping

Shipping and routing instructions are required for each third-party shipment. If no such instructions are received, we have the right to ship by carrier of our choice. If billing a third-party, the payer's discount program will take precedence; please consult your carrier for a freight quote.

Customer pickup is available from our distribution centre, a pickup appointment must be booked before arrival. The link to do that is <https://bumoutdoor.ca/pickup/>. If customers come to the warehouse without an appointment they will be turned away, missed pickups may be subject to additional fees.

Refusals

If a shipment is refused, re-consigned, re-delivered, storage or additional services are rendered that were not mentioned at the time of the freight quote/shipment, the customer is responsible for all additional charges incurred, and applicable re-stocking fees.

Freight Quotes

Freight quotes provided by Bum Commercial Furniture must be sent alongside any orders. If a freight estimate # is not received, freight will be requested. Please ensure that when requesting a freight quote you send it to freight@bumoutdoor.ca with the appropriate information required and/or fill out the form on our website <https://bumoutdoor.ca/freight-quote/>. Freight quotes will be done as quickly as possible, please try to keep the number of revisions of freight requests to a minimum so we can serve as many customers as we can in a timely manner.

Stock Hold/Storage Fees

Product cannot be reserved or held for over 30 days unless a 25% deposit is received. Orders will be held for up to 6 months. After 6 months, a storage fee of \$25+tax will be charged per pallet worth of product. This storage amount will be added to the sales order/invoice and must be paid in full before shipping/pickup or by the payment date noted on your invoice.

Third-Party Reselling

Bum Commercial Furniture does not authorize third party reselling (the practice of an authorized Bum Dealer selling Bum to another retailer). Authorized Bum Dealers must be clearly identified and fulfil the order.

Claims & Damages

Bum Commercial Furniture carefully packages its products and inspects them thoroughly before they leave the warehouse. Photos are also taken. It is the duty of the receiving party/consignee to inspect and receive all merchandise immediately upon arrival for any visual and/or concealed damage. Effective immediately: all freight deliveries from Bum Commercial Furniture are required to be inspected by the receiving party/consignee before the carrier leaves their facility. A signature and note of any potential damage must be clearly documented in detail on the Bill of Lading.

If freight damage is discovered after the carrier has left the facility and has not been documented on the Bill of Lading, those damages and/or replacements will be the responsibility of the receiving party/consignee. The product will not be eligible for refund or replacement by Bum Commercial Furniture.

Products with freight damage from all Third-Party and Collect shipments (including pickups) are not eligible for replacement by Bum Commercial Furniture. Customers must contact their carrier directly.

Freight Claims & Damages

VIA 3rd Party

If a specific carrier was requested on the purchase order, the customer takes full responsibility for all freight issues, including contacting the carrier, damages, losses, and additional freight charges, and claims.

VIA Carrier

Before accepting and signing the merchandise from the carrier, inspect all cartons for visible or concealed damage and clearly note any loss or damage on the delivery receipt/Bill of Lading. If there is loss or damage, make an immediate claim with the delivery carrier. In the event of concealed damage, save all cartons and packing materials and notify the freight carrier and Bum Commercial Furniture immediately for inspection. Missing items/parts/hardware claims against us will be considered only if filed with us via our website <https://bumoutdoor.ca/warranty/> within 3 days of the delivery date. Failure to make such a claim shall constitute acceptance of the merchandise and waived of any defects, errors, or shortages. Bum Commercial Furniture is not responsible for damage or loss incurred in transit. All furniture is shipped at the purchaser's own risk after it has been inspected and securely packaged at the distribution centre. It is accepted as such by the freight carrier.

General Maintenance

As with any piece of equipment, proper and periodic maintenance is necessary to ensure the longevity of the product and customer satisfaction. To ensure you get the most out of your investment, please follow our recommended maintenance and care instructions.

We recommend that the products be examined every 30 days. Items requiring adjustments, showing any sign of structural failure, missing hardware, or showing any cracks at the welds should be taken out of service immediately until repaired.

Loose screws should be tightened as required and missing or worn-out foot caps must be replaced. To obtain replacement parts, please contact your local sales representative and/or info@bumoutdoor.ca.

Furniture should be handled with care. When chairs are stacked, the stack should not be dragged. Stackable chairs should not be dropped or slammed down when being unstacked. People should not rock back or stand on the seats.

For storage, all furniture should be stored neatly, stacked to the suggested height, and packed in a clean and dry area. Tables should not be flipped and stacked. Any standing water needs to be removed to avoid damage to the finish. Cushions that are stored for longer periods of time should be stored in a well ventilated area.

Note: warranty may be voided if proper maintenance or care is not followed. Proof of care and maintenance is required with claims being made.

Warranty

Bum Commercial Furniture has a 3 year limited warranty on all products. The limited warranty does not apply to damage resulting from accident, alteration, misuse, tampering, negligence, abuse or normal wear and tear. All items must be properly assembled and taken care of as per instructions. Upkeep of product (i.e. replacing chair feet) is the responsibility of the customer.

Warranty is only valid if all parts that can wear (i.e. foot caps) are replaced annually. Parts must be purchased within one month of replacement time and proper maintenance must be followed. Product failure caused by lack of reasonable and necessary care and maintenance is not covered under warranty.









P & E OUTDOOR
FURNITURE
INSTALLATION

INSTALLATION
MAINTENANCE
SHRINK WRAPPING



SERVICES PROVIDED

- ✓ Commercial & Residential
Patio Opening/Closing
- ✓ Pergola & Umbrella Installation
- ✓ Shrink Wrapping
- ✓ Maintenance



Patrick Curry



905.302.0216



patioinstallation@gmail.com



@pne_outdoor_furniture_installs

10 Years Experience With Bum Outdoor Products



OFFICE / SHOWROOM / DISTRIBUTION

**1-3270 SOUTH SERVICE ROAD WEST
OAKVILLE, ONTARIO L6L 0B1**

📞 1-855-337-2995 ✉ info@bumoutdoor.ca



WWW.BUMOUTDOOR.CA